



ENGLISH  
FRANÇAIS  
ESPAÑOL

# KD-X350BTS / KD-X255BT / KD-X35MBS

DIGITAL MEDIA RECEIVER

## INSTRUCTION MANUAL

RÉCEPTEUR MULTIMÉDIA NUMÉRIQUE

## MANUEL D'INSTRUCTIONS

RECEPTOR DE MEDIOS DIGITALES

## MANUAL DE INSTRUCCIONES

JVCKENWOOD Corporation



**For customer Use:**

Enter below the Model No. and Serial No. which are located on the top or bottom of the cabinet. Retain this information for future reference.

Model No. \_\_\_\_\_  
Serial No. \_\_\_\_\_

B5A-2132-00 [K]

**Información acerca de la eliminación de equipos eléctricos y electrónicos al final de la vida útil (aplicable a los países que hayan adoptado sistemas independientes de recogida de residuos)**



Los productos con el símbolo de un contenedor con ruedas tachado no podrán ser desechados como residuos domésticos. Los equipos eléctricos y electrónicos al final de la vida útil, deberán ser reciclados en instalaciones que puedan dar el tratamiento adecuado a estos productos y a sus subproductos residuales correspondientes. Póngase en contacto con su administración local para obtener información sobre el punto de recogida más cercano. Un tratamiento correcto del reciclaje y la eliminación de residuos ayuda a conservar los recursos y evita al mismo tiempo efectos perjudiciales en la salud y el medio ambiente.

**Informação sobre a eliminação de pilhas**

Este produto não deve ser eliminado como lixo doméstico geral. Devolva a pilha usada ao revendedor ou entidade autorizada para que a mesma seja devolvida ao fabricante ou importador. A reciclagem e a eliminação de lixo de maneira apropriada ajudarão a conservar os recursos naturais ao mesmo tempo que prevenirão os efeitos prejudiciais à nossa saúde e ao meio ambiente.

**CALIFORNIA, USA ONLY**

This product contains a CR Coin Cell Lithium Battery which contains Perchlorate Material—special handling may apply. See [www.dtsc.ca.gov/hazardouswaste/perchlorate](http://www.dtsc.ca.gov/hazardouswaste/perchlorate)

**FCC WARNING**

This equipment may generate or use radio frequency energy. Changes or modifications to this equipment may cause harmful interference unless the modifications are expressly approved in the instruction manual. The user could lose the authority to operate this equipment if an unauthorized change or modification is made.

**FCC NOTE**

This equipment has been tested and found to comply with the limits for a Class B digital device, pursuant to Part 15 of the FCC Rules. These limits are designed to provide reasonable protection against harmful interference in a residential installation. This equipment may cause harmful interference to radio communications, if it is not installed and used in accordance with the instructions. However, there is no guarantee that interference will not occur in a particular installation. If this equipment does cause harmful interference to radio or television reception, which can be determined by turning the equipment off and on, the user is encouraged to try to correct the interference by one or more of the following measures:

- Reorient or relocate the receiving antenna.
- Increase the separation between the equipment and receiver.
- Connect the equipment into an outlet on a circuit different from that to which the receiver is connected.
- Consult the dealer or an experienced radio/TV technician for help.

**IC (Industry Canada) Notice**

This device complies with Industry Canada's licence-exempt RSSs.

Operation is subject to the following two conditions:

- (1) This device may not cause interference, and
- (2) this device must accept any interference, including interference that may cause undesired operation of the device.

**Note de IC (Industrie Canada)**

Le présent appareil est conforme aux CNR d'Industrie Canada applicables aux appareils radio exempts de licence.

L'exploitation est autorisée aux deux conditions suivantes:

- (1) l'appareil ne doit pas produire de brouillage;
- (2) l'utilisateur de l'appareil doit accepter tout brouillage radioélectrique subi, même si le brouillage est susceptible d'en compromettre le fonctionnement.

|                           |         |              |
|---------------------------|---------|--------------|
| Contains Bluetooth Module | FCC ID: | ZWY8811X     |
|                           | IC ID:  | 12033A-8811X |

This transmitter must not be co-located or operated in conjunction with any other antenna or transmitter.

**CAUTION**

This equipment complies with FCC/IC radiation exposure limits set forth for an uncontrolled environment and meets the FCC radio frequency (RF) Exposure Guidelines and RSS-102 of the IC radio frequency (RF) Exposure rules. This equipment has very low levels of RF energy that it deemed to comply without maximum permissive exposure evaluation (MPE). But it is desirable that it should be installed and operated keeping the radiator at least 20cm or more away from person's body.

**ATTENTION**

Cet équipement est conforme aux limites d'exposition aux rayonnements énoncées pour un environnement non contrôlé et respecte les règles les radioélectriques (RF) de la FCC lignes directrices d'exposition et d'exposition aux fréquences radioélectriques (RF) CNR-102 de l'IC. Cet équipement émet une énergie RF très faible qui est considérée comme conforme sans évaluation de l'exposition maximale autorisée (MPE). Cependant, il est souhaitable qu'il devrait être installé et utilisé en gardant une distance de 20 cm ou plus entre le radiateur et le corps humain.

**Para cumplimiento de la IFT:**

"La operación de este equipo está sujeta a las siguientes dos condiciones:

- (1) es posible que este equipo o dispositivo no cause interferencia perjudicial y
- (2) este equipo o dispositivo debe aceptar cualquier interferencia, incluyendo la que pueda causar su operación no deseada"

# SOFTWARE LICENSE AGREEMENT

The software embedded in the Product (hereinafter the "Licensed Software") provided by Licensor is copyrighted to or sublicensable by the Licensor, and this Agreement provides for the terms and conditions which Users shall follow in order to use the Licensed Software.

The User shall use the Licensed Software by agreeing with the terms of this Software License Agreement. This Agreement shall be deemed completed at the time the User (hereinafter the "User") initially used the Product in which the "Licensed Software" is embedded.

The Licensed Software may include the software which has been licensed to the Licensor directly or indirectly from any third party. In such case, some third parties require the Users to follow their conditions for use separately from this Software License Agreement. Such software shall not be subject to this Agreement, and the Users are urged to read the "Important Notice concerning the Software" to be provided separately below.

## Article 1 General Provision

The Licensor shall grant to the User a non-exclusive and non-transferable (other than the exceptional case referred to in Article 3, Paragraph 1) licensed to use the Licensed Software within the country of the User. (the country where the User bought the Product(hereinafter the "Country"))

## Article 2 License

1. The license granted under this Agreement shall be the right to use the Licensed Software in the Product.
2. The User shall not duplicate, copy, modify, add, translate or otherwise alter, or lease the Licensed Software and any related documents, whether in whole or in part.
3. The use of the Licensed Software shall be limited to personal purpose, and the Licensed Software shall not be distributed, licensed or sub-licensed whether it is for commercial purpose or not.
4. The User shall use the Licensed Software according to the directions described in the operation manual or help file, and is prohibited to use or duplicate any data in a manner violating the Copyright Law or any other laws and regulations by applying whole or a part of the Licensed Software.

## Article 3 Conditions for Grant of License

1. When the User transfers the Product, it may also transfer the license to use the Licensed Software embedded in the Product (including any related materials, updates and upgrades) on condition that no original, copies or related materials continue in the possession of the User, and that the User shall cause the transferee to comply with this Software License Agreement.
2. The User shall not carry out reverse engineering, disassembling, decompiling or any other code analysis works in connection with the Licensed Software.

## Article 4 Right pertaining to the Licensed Software

Any and all copyrights and other rights pertaining to the Licensed Software and related documents shall belong to the Licensor or the original holder of the right who granted to the Licensor the license or sublicense for the Licensed Software (hereinafter the "Original Rightholder"), and the User shall not be entitled to any right other than the license granted hereunder, in respect of the Licensed Software and any related documents.

## Article 5 Indemnification of Licensor

1. Neither the Licensor nor the Original Rightholder shall be liable for any damage incurred by the User or any third party due to the exercise of the license granted to the User under this Agreement, unless otherwise restricted by law.
2. The Licensor will offer no guarantee for the merchantability, convertibility and consistency with certain objective of the Licensed Software.

## Article 6 Liability to Third Party

If any dispute has arisen with any third party due to an infringement upon a copyright, patent or any other intellectual property right that was caused by the User's use of the Licensed Software, the User shall settle such dispute at its own cost and hold the Licensor and the Original Rightholder harmless from any inconvenience it may cause.

## Article 7 Confidentiality

The User shall keep the confidentiality of such portion of the Licensed Software, related documents thereof or any other information to be granted under this Agreement, as well as the conditions of this Agreement as has not yet entered the public domain, and shall not disclose or divulge the same to any third party without approval of the Licensor.

## **Article 8 Termination**

In case the User falls under any of the events described in the following items, the Licensor may immediately terminate this Agreement or claim that the User compensates for the damage incurred by the Licensor due to such event:

- (1) when the User violated any provision of this Agreement; or
- (2) when a petition has been filed against the User for an attachment, provisional attachment, provisional disposition or any other compulsory execution.

## **Article 9 Destruction of the Licensed Software**

If this Agreement is terminated pursuant to the provision of Article 8, the User shall destroy the Licensed Software, any related documents and copies thereof within two (2) weeks from such date of termination.

## **Article 10 Protection of Copyright**

1. The copyright and all the other intellectual property rights relating to the Licensed Software shall belong to the Licensor and the Original Rightholder, and in no event shall they be under the ownership of the User.
2. The User shall, whenever it uses the Licensed Software, comply with any laws relating to the copyright and other intellectual property rights.

## **Article 11 Export Restriction**

1. It is prohibited to export the Licensed Software and any related documents outside the country of the User (including transmission thereof outside the country of the User via Internet or other communication tools).
2. The User shall understand that the Licensed Software shall be subject to the export restrictions adopted by the country of User and any other countries.
3. The User shall agree that the software will be subject to any and all applicable international and domestic laws (including the export control regulation of the country of User and any other countries, and any restrictions concerning the end-users, the use by end-users and importing countries to be provided by the country of User and any other countries, and any other governmental authorities).

## **Article 12 Miscellaneous**

1. In the event any part of this Agreement is invalidated by operation of law, the residual provisions shall continue in force.
2. Matters not stipulated in this Agreement or any ambiguity or question raised in the construction of this Agreement shall be provided or settled upon good-faith consultation between the Licensor and the User.
3. The Licensor and the User hereby agree that this Agreement is governed by the laws of Japan, and any dispute arising from, and relating to the rights and obligations under, this Agreement shall be submitted to the exclusive jurisdiction of the Tokyo District Court for its first instance.

## **Important Notice concerning the Software**

-jansson

Copyright (c) 2009-2012 Petri Lehtinen <petri@digip.org>

Permission is hereby granted, free of charge, to any person obtaining a copy of this software and associated documentation files (the "Software"), to deal in the Software without restriction, including without limitation the rights to use, copy, modify, merge, publish, distribute, sublicense, and/or sell copies of the Software, and to permit persons to whom the Software is furnished to do so, subject to the following conditions:

The above copyright notice and this permission notice shall be included in all copies or substantial portions of the Software.

THE SOFTWARE IS PROVIDED "AS IS", WITHOUT WARRANTY OF ANY KIND, EXPRESS OR IMPLIED, INCLUDING BUT NOT LIMITED TO THE WARRANTIES OF MERCHANTABILITY, FITNESS FOR A PARTICULAR PURPOSE AND NONINFRINGEMENT. IN NO EVENT SHALL THE AUTHORS OR COPYRIGHT HOLDERS BE LIABLE FOR ANY CLAIM, DAMAGES OR OTHER LIABILITY, WHETHER IN AN ACTION OF CONTRACT, TORT OR OTHERWISE, ARISING FROM, OUT OF OR IN CONNECTION WITH THE SOFTWARE OR THE USE OR OTHER DEALINGS IN THE SOFTWARE.

# CONTENTS

|                             |    |
|-----------------------------|----|
| BEFORE USE                  | 2  |
| BASICS                      | 3  |
| GETTING STARTED             | 4  |
| 1 Cancel the demonstration  |    |
| 2 Set the clock and date    |    |
| 3 Set the basic settings    |    |
| RADIO                       | 5  |
| USB/iPod/ANDROID            | 7  |
| Pandora®                    | 9  |
| iHeartRadio®                | 10 |
| Spotify                     | 11 |
| SiriusXM® Radio             | 12 |
| BLUETOOTH®                  | 15 |
| AUX                         | 23 |
| AUDIO SETTINGS              | 23 |
| DISPLAY SETTINGS            | 28 |
| REFERENCES                  | 29 |
| Maintenance                 |    |
| More information            |    |
| TROUBLESHOOTING             | 33 |
| SPECIFICATIONS              | 36 |
| INSTALLATION/<br>CONNECTION | 37 |

# BEFORE USE

## IMPORTANT

- To ensure proper use, please read through this manual before using this product. It is especially important that you read and observe Warning and Caution in this manual.
- Please keep the manual in a safe and accessible place for future reference.

## ⚠ WARNING

- **Do not operate any function that takes your attention away from safe driving.**
- **Do not ingest the battery, Chemical Burn Hazard**  
The remote control supplied with this product contains a coin/button cell battery.  
If the coin/button cell battery is swallowed, it can cause severe internal burns in just 2 hours and can lead to death.  
Keep new and used batteries away from children.  
If the battery compartment does not close securely, stop using the product and keep it away from children.  
If you think batteries might have been swallowed or placed inside any part of the body, seek immediate medical attention.

## ⚠ Caution

### Volume setting:

- Adjust the volume so that you can hear sounds outside the car to prevent accidents.
- Lower the volume before playing digital sources to avoid damaging the speakers by the sudden increase of the output level.

### General:

- Avoid using the external device if it might hinder safe driving.
- Make sure all important data has been backed up. We shall bear no responsibility for any loss of recorded data.
- Never put or leave any metallic objects (such as coins or metal tools) inside the unit to prevent a short circuit.
- Depending on the types of cars, the antenna will automatically extend when you turn on the unit with the antenna control wire connected (→ 39). Turn off the unit when parking at a low ceiling area.

### Remote control (RM-RK52):

- Do not leave the remote control in hot places such as on the dashboard.
- The Lithium battery is in danger of explosion if replaced incorrectly. Replace it only with the same or equivalent type.
- The battery pack or batteries shall not be exposed to excessive heat such as sunshine, fire or the like.

### How to read this manual

- Operations are explained mainly using buttons on the faceplate of **KD-X350BTS**.
- English indications are used for the purpose of explanation. You can select the display language from the menu. (→ 5)
- [XX] indicates the selected items.
- (→ XX) indicates references are available on the stated page.

# BASICS

## Faceplate

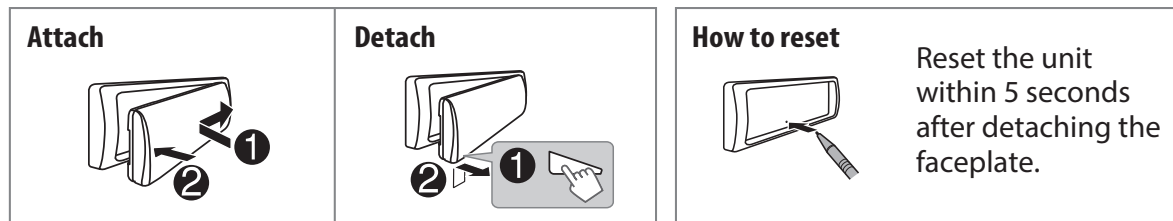
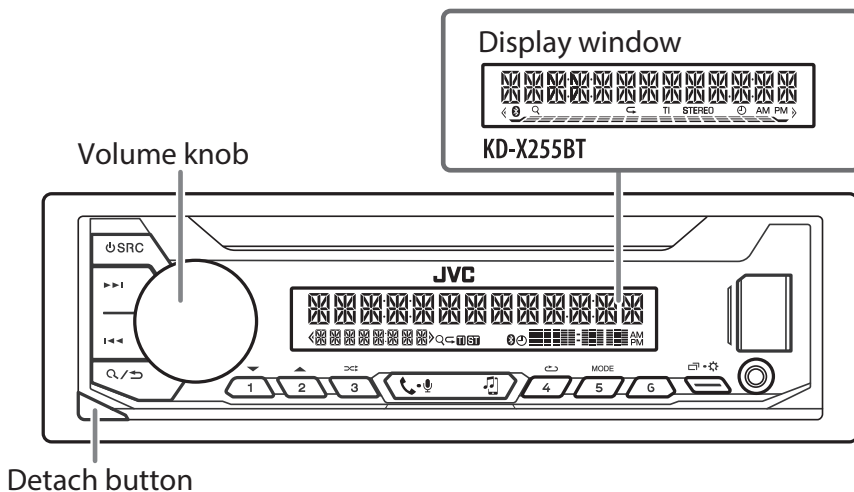

| To                             | On the faceplate   | On the remote control   |
|--------------------------------|--|---|
| Turn on the power              | Press <b>SRC</b> .<br>• Press and hold to turn off the power.  | ( Not available )   |
| Adjust the volume              | Turn the volume knob.<br><br>Press the volume knob to mute the sound or pause playback.<br>• Press again to cancel. The volume level returns to the previous level before muting or pause. | Press <b>VOL +</b> or <b>VOL -</b> .<br>• Press and hold <b>VOL +</b> to continuously increase the volume to 15.<br><br>Press <b>MUTE</b> to mute the sound or pause playback.<br>• Press again to cancel. The volume level returns to the previous level before muting or pause. |
| Select a source                | • Press <b>SRC</b> repeatedly.<br>• Press <b>SRC</b> , then turn the volume knob within 2 seconds.   | Press <b>SOURCE</b> repeatedly.   |
| Change the display information | Press <b>INFO</b> repeatedly. (→ 31, 32)   | ( Not available )   |

## Remote control (RM-RK52)

This unit can be remotely controlled with an optionally purchased remote control.

Remote sensor (Do not expose to bright sunlight.)

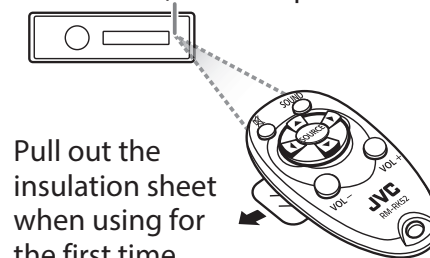

## How to replace the battery



# GETTING STARTED

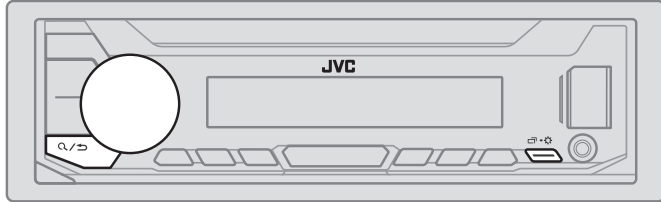

## 1 Cancel the demonstration

When you turn on the power for the first time (or [FACTORY RESET] is set to [YES]), the display shows: "CANCEL DEMO" → "PRESS" → "VOLUME KNOB"

- 1 Press the volume knob.  
[YES] is selected for the initial setup.
- 2 Press the volume knob again.  
"DEMO OFF" appears.

## 2 Set the clock and date

- 1 Press and hold .
  - 2 Turn the volume knob to select [CLOCK], then press the knob.
- To adjust the clock**
- 3 Turn the volume knob to select [CLOCK ADJUST], then press the knob.
  - 4 Turn the volume knob to make the settings, then press the knob.  
Hour → Minute
  - 5 Turn the volume knob to select [CLOCK FORMAT], then press the knob.
  - 6 Turn the volume knob to select [12H] or [24H], then press the knob.

### To set the date

- 7 Turn the volume knob to select [DATE SET], then press the knob.
- 8 Turn the volume knob to make the settings, then press the knob.  
Day → Month → Year
- 9 Press to exit.

To return to the previous setting item, press .

## 3 Set the basic settings

- 1 Press and hold .
- 2 Turn the volume knob to select an item (see the following table), then press the knob.
- 3 Repeat step 2 until the desired item is selected or activated.
- 4 Press to exit.

To return to the previous setting item, press .

Default: **XX**

|                      |   |
|----------------------|---|
| <b>SYSTEM</b>        |   |
| <b>KEY BEEP</b>      | (Not applicable when 3-way crossover is selected.)<br><b>ON:</b> Activates the keypress tone. ; <b>OFF:</b> Deactivates.  |
| <b>SOURCE SELECT</b> |   |
| <b>AM SRC*</b>       | <b>ON:</b> Enables AM in source selection. ; <b>OFF:</b> Disables. (→ 5)  |
| <b>PANDORA SRC*</b>  | <b>ON:</b> Enables PANDORA in source selection. ; <b>OFF:</b> Disables. (→ 9)   |
| <b>IHEART SRC*</b>   | <b>ON:</b> Enables IHEARTRADIO in source selection. ; <b>OFF:</b> Disables. (→ 10)  |
| <b>SPOTIFY SRC*</b>  | <b>ON:</b> Enables SPOTIFY in source selection. ; <b>OFF:</b> Disables. (→ 11)  |
| <b>BUILT-IN AUX*</b> | <b>ON:</b> Enables AUX in source selection. ; <b>OFF:</b> Disables. (→ 23)  |
| <b>F/W UPDATE</b>    |   |
| <b>UPDATE SYSTEM</b> |   |
| <b>F/W UP xxxx</b>   | <b>YES:</b> Starts upgrading the firmware. ; <b>NO:</b> Cancels (upgrading is not activated).<br>For details on how to update the firmware, visit<br>< <a href="http://www.jvc.net/cs/car/">http://www.jvc.net/cs/car/</a> >. |
| <b>FACTORY RESET</b> | <b>YES:</b> Resets the settings to default (except the stored station). ;<br><b>NO:</b> Cancels.  |

\* Not displayed when the corresponding source is selected.



## GETTING STARTED

### CLOCK

**TIME SYNC** **ON:** The clock time is automatically set using the Clock Time (CT) data in FM Radio Broadcast Data System signal. ; **OFF:** Cancels.

**CLOCK DISPLAY** **ON:** The clock time is shown on the display even when the unit is turned off. ; **OFF:** Cancels.

**ENGLISH** Select the display language for menu and music information if applicable.

**ESPAÑOL** By default, **ENGLISH** is selected.

## RADIO

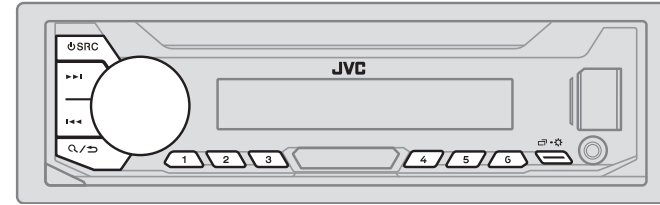

“ST” or “STEREO” lights up when receiving an FM stereo broadcast with sufficient signal strength.

### Search for a station

- 1 Press **SRC** repeatedly to select FM or AM.
- 2 Press **◀◀ / ▶▶** (or press **◀ / ▶** on the remote control) to search for a station automatically.  
(or)  
Press and hold **◀◀ / ▶▶** (or press and hold **◀ / ▶** on the remote control) until “M” flashes, then press repeatedly to search for a station manually.

### Settings in memory

You can store up to 18 stations for FM and 6 stations for AM.

#### ■ Store a station

While listening to a station....

Press and hold one of the number buttons (1 to 6).

(or)

- 1 Press and hold the volume knob until “PRESET MODE” flashes.
- 2 Turn the volume knob to select a preset number, then press the knob.  
The preset number flashes and “MEMORY” appears.

#### ■ Select a stored station





Press one of the number buttons (1 to 6).

(or)

- 1 Press **R / ↵**.
- 2 Turn the volume knob to select a preset number, then press the knob.

# RADIO

## Other settings

- 1 Press and hold  · .
- 2 Turn the volume knob to select an item (see the following table), then press the knob.
- 3 Repeat step 2 until the desired item is selected/activated or follow the instructions stated on the selected item.
- 4 Press  ·  to exit.

To return to the previous setting item, press  / .

Default: **XX**

## TUNER SETTING

|                    |  |
|--------------------|--|
| <b>RADIO TIMER</b> | <p>Turns on the radio at a specific time regardless of the current source.</p> <ol style="list-style-type: none"> <li>1 <b>ONCE/DAILY/WEEKLY/OFF</b>: Select how often the timer will be turned on.</li> <li>2 <b>FM/AM/SIRIUS XM</b>*1: Select the source.</li> <li>3 <b>01 to 18</b> (for FM/SIRIUS XM)/<b>01 to 06</b> (for AM): Select the preset station.</li> <li>4 Set the activation day*2 and time.<br/>“☺” lights up when complete.</li> </ol> <p>Radio Timer will not activate for the following cases.</p> <ul style="list-style-type: none"> <li>• The unit is turned off.</li> <li>• <b>[OFF]</b> is selected for <b>[AM SRC]</b> in <b>[SOURCE SELECT]</b> after Radio Timer for AM is selected. (➔ 4)</li> </ul> |
| <b>SSM</b>         | <p><b>SSM 01–06/SSM 07–12/SSM 13–18</b>: Automatically presets up to 18 stations for FM. “SSM” stops flashing when the first 6 stations are stored. Select <b>SSM 07–12/SSM 13–18</b> to store the following 12 stations.</p>  |

|                      |   |
|----------------------|---|
| <b>IF BAND</b>       | <p><b>AUTO</b>: Increases the tuner selectivity to reduce interference noises from adjacent FM stations. (Stereo effect may be lost.) ; <b>WIDE</b>: Subjects to interference noises from adjacent FM stations, but sound quality will not be degraded and the stereo effect will remain.</p> |
| <b>MONO SET</b>      | <p><b>ON</b>: Improves the FM reception, but the stereo effect will be lost. ; <b>OFF</b>: Cancels.</p>   |
| <b>AREA</b>          | <p><b>N.AMERICA</b>: For North/Central/South America, AM/FM intervals: 10 kHz/200 kHz. ; <b>S.AMERICA</b>: For some South American countries, AM/FM intervals: 10 kHz/50 kHz. ; <b>EUROPE</b>: For any other areas, AM/FM intervals: 9 kHz/50 kHz.</p>  |
| <b>PTY SEARCH</b> *3 | <p>Select a PTY code (see below).<br/>If there is a station broadcasting a program of the same PTY code as you have selected, that station is tuned in.</p>   |

- \*1 For **KD-X350BTS/KD-X35MBBS**: Selectable only when SiriusXM Vehicle Tuner is connected. (➔ 12)
- \*2 Selectable only when **[ONCE]** or **[WEEKLY]** is selected in step 1.
- \*3 Only for FM source.

## PTY code

**NEWS, INFORM** (information), **SPORTS, TALK, ROCK, CLS ROCK** (classic rock), **ADLT HIT** (adult hits), **SOFT RCK** (softrock), **TOP 40, COUNTRY, OLDIES, SOFT, NOSTALGA** (nostalgia), **JAZZ, CLASSICL** (classical), **R & B** (rhythm and blues), **SOFT R&B** (soft rhythm and blues), **LANGUAGE, REL MUSC** (religious music), **REL TALK** (religious talk), **PERSNLTY** (personality), **PUBLIC, COLLEGE, HABL ESP** (Spanish talk), **MUSC ESP** (Spanish music), **HIP HOP, WEATHER**

# USB/iPod/ANDROID

## Start playback

The source changes automatically and playback starts.

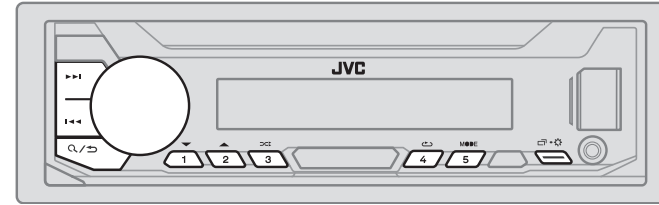
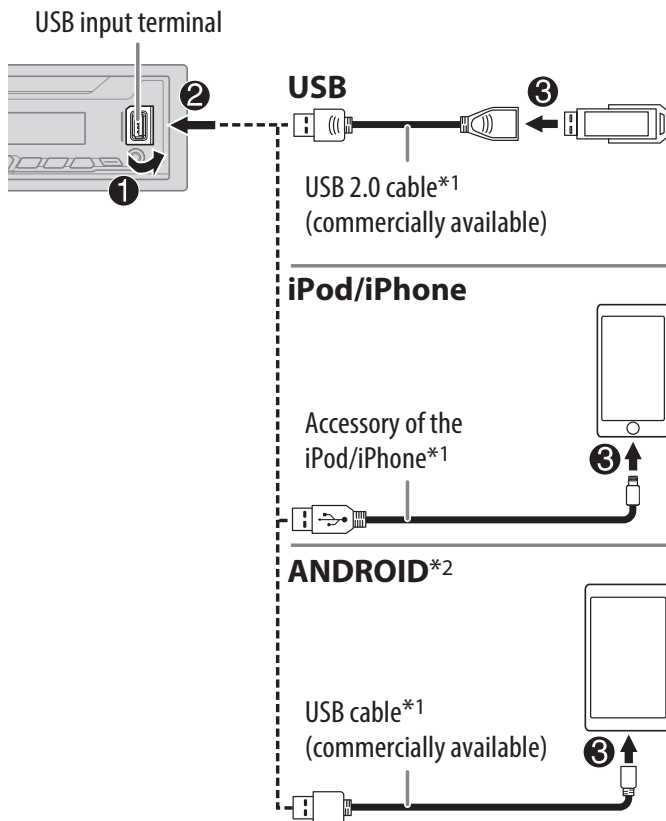

| To                     | On the faceplate   | On the remote control |
|------------------------|--|-----------------------|
| Reverse/Fast-forward*3 | Press and hold  ◀◀ / ▶▶ .  | Press and hold ◀/▶.   |
| Select a file          | Press  ◀◀ / ▶▶ .   | Press ◀/▶.            |
| Select a folder*4      | Press 2 ▲ / 1 ▼.   | Press ▲/▼.            |
| Repeat play*5          | Press 4 ↻ repeatedly.<br>TRACK REPEAT/FOLDER REPEAT/ALL REPEAT : MP3/WMA/AAC/WAV/<br>FLAC file<br>ONE REPEAT/ALL REPEAT/REPEAT OFF : iPod or ANDROID |                       |
| Random play*5          | Press 3 ⌛ repeatedly.<br>FOLDER RANDOM/ALL RANDOM/RANDOM OFF : MP3/WMA/AAC/WAV/<br>FLAC file<br>SONG RANDOM/ALL RANDOM/RANDOM OFF : iPod or ANDROID  |                       |

\*1 Do not leave the cable inside the car when not using.

\*2 When connecting an Android device, "Press [VIEW] to install JVC MUSIC PLAY APP" is shown. Follow the instructions to install the application. You can also install the latest version of JVC MUSIC PLAY application on your Android device before connecting. For more information, visit <<http://www.jvc.net/cs/car/>>.

\*3 For ANDROID: Applicable only when [AUTO MODE] is selected. (➡ 8)

\*4 Only for MP3/WMA/AAC/WAV/FLAC files. This does not work for iPod/ANDROID.

\*5 For iPod/ANDROID: Applicable only when [HEAD MODE]/[AUTO MODE] is selected. (➡ 8)

## USB/iPod/ANDROID

### Select control mode

While in iPod USB source, press **5 MODE** repeatedly.

**HEAD MODE:** Control iPod from this unit.

**IPHONE MODE:** Control iPod using the iPod itself. However, you can still play/pause or file skip from this unit.

While in ANDROID source, press **5 MODE** repeatedly.

**AUTO MODE:** Control Android device from this unit via JVC MUSIC PLAY application installed in the Android device.

**AUDIO MODE:** Control Android device using the Android device itself via other media player applications installed in the Android device. However, you can still play/pause or file skip from this unit.

### Select music drive

While in USB source, press **5 MODE** repeatedly.

Stored songs in the following drive will be played back.

- Selected internal or external memory of a smartphone (Mass Storage Class).
- Selected drive of a multiple drives device.

### Settings to use JVC Remote application

JVC Remote application is designed to control the JVC car receiver's operations from the iPhone/iPod (via USB input terminal).

#### Preparation:

Install the latest version of JVC Remote application on your device before connecting. For more information, visit <<http://www.jvc.net/cs/car/>>.

You can make the settings in the same way as connection via Bluetooth.  
(→ 21)

### Select a file from a folder/list

For iPod/ANDROID, applicable only when [HEAD MODE]/[AUTO MODE] is selected.

- 1 Press **Q/↵**.
- 2 Turn the volume knob to select a folder/list, then press the knob.
- 3 Turn the volume knob to select a file, then press the knob.

#### Quick search (applicable only for USB and ANDROID source)

If you have many files, you can search through them quickly.

Turn the volume knob quickly to browse through the list quickly.

#### Alphabet search (applicable only for iPod USB and ANDROID source)

You can search for a file according to the first character.

##### For iPod USB source

Press **2 ▲ / 1 ▼** or turn the volume knob quickly to select the desired character (A to Z, 0 to 9, OTHERS).

- Select "OTHERS" if the first character is other than A to Z, 0 to 9.

##### For ANDROID source

- 1 Press **2 ▲ / 1 ▼** to enter character search.
- 2 Turn the volume knob to select the desired character.
  - ^A^: Upper case letters (A to Z)
  - \_A\_: Lower case letters (a to z)
  - 0-: Numbers (0 to 9)
  - OTHERS-: Character other than A to Z, 0 to 9
- 3 Press the volume knob to start searching.

- To return to the previous setting item, press **Q/↵**.
- To cancel, press and hold **Q/↵**.

# Pandora®

## Preparation:

Install the latest version of the Pandora application on your device (iPhone/iPod touch), then create an account and log in to Pandora.

- Select [ON] for [PANDORA SRC] in [SOURCE SELECT]. (→ 4)

## Start listening

- 1 Open the Pandora application on your device.
- 2 Connect your device to the USB input terminal.

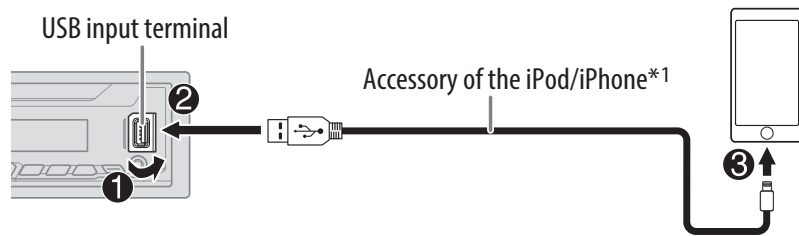

- 3 Press **SRC** repeatedly to select PANDORA.  
Broadcast starts automatically.

| To                         | On the faceplate         | On the remote control   |
|----------------------------|--------------------------|---|
| Playback/pause             | Press the volume knob.   | Press  . |
| Skip a track               | Press <b>▶▶</b> .        | Press <b>▶</b> .  |
| Thumbs up or thumbs down*2 | Press <b>2 ▲ / 1 ▼</b> . | Press <b>▲ / ▼</b> .  |

\*1 Do not leave the cable inside the car when not using.

\*2 If thumbs down is selected, the current track is skipped.

## Create and store a new station

- 1 Press **Q/↵**.
- 2 Turn the volume knob to select [NEW STATION], then press the knob.
- 3 Turn the volume knob to select [FROM TRACK] or [FROM ARTIST], then press the knob.

A new station is created based on the current song or artist.

- 4 Press and hold one of the number buttons (**3, 4, 5** or **6**) to store.

To select a stored station: Press one of the number buttons (**3, 4, 5** or **6**).

## Search for a registered station

- 1 Press **Q/↵**.
- 2 Turn the volume knob to select an item, then press the knob.  
[BY DATE]: According to the registered date  
[A-Z]: By alphabetical order
- 3 Turn the volume knob to select the desired station, then press the knob.

To cancel, press and hold **Q/↵**.

## Bookmark current song information

Press and hold the volume knob.

"BOOKMARKED" appears and the information is stored to your device.

- The bookmark is available on your Pandora account but not on this unit.

# iHeartRadio®

## Preparation:

Install the latest version of iHeartAuto application on your device (iPhone/iPod touch), then create an account and log in to iHeartRadio.

- Select [ON] for [IHEART SRC] in [SOURCE SELECT]. (→ 4)

## Start listening

- 1 Open the iHeartAuto application on your device.
- 2 Connect your device to the USB input terminal.

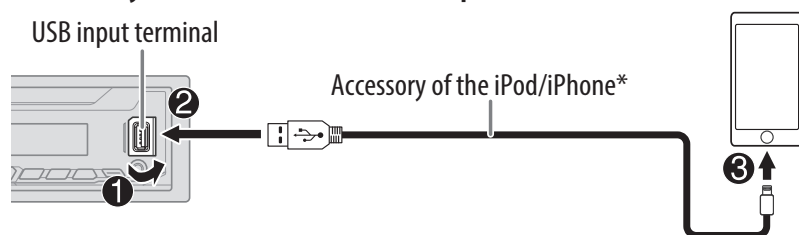

- 3 Press **SRC** repeatedly to select IHEARTRADIO.  
Broadcast starts automatically

\* Do not leave the cable inside the car when not using.

| To                              | On the faceplate  | On the remote control |
|---------------------------------|---|-----------------------|
| Playback/pause                  | Press the volume knob.  | Press                 |
| Skip a track for custom station | Press   | Press                 |
| Thumbs up or thumbs down        | Press <b>2 ▲</b> / <b>1 ▼</b> .   | Press                 |
| Create a new/custom station     | Press and hold the volume knob.   | ( Not available )     |
| Scan for live station           | <ol style="list-style-type: none"> <li>1 Press <b>3</b> to start scanning.</li> <li>2 Press <b>3</b> again to listen to the station.</li> </ol> | ( Not available )     |

## Search and store a station

- 1 Press
- 2 Turn the volume knob to select a category, then press the knob.
- 3 Turn the volume knob to select the desired station, then press the knob.  
When a city list appears, you can search cities in alphabetical order by turning the volume knob quickly.

To cancel, press and hold .

**To store a station:** Press and hold one of the number buttons (**4**, **5** or **6**).

**To select a stored station:** Press one of the number buttons (**4**, **5** or **6**).

# Spotify

## Preparation:

Install the latest version of the Spotify application on your device (iPhone/iPod touch), then create an account and log in to Spotify.

- Select [ON] for [SPOTIFY SRC] in [SOURCE SELECT]. (→ 4)

## Start listening

- 1 Open the Spotify application on your device.
- 2 Connect your device to the USB input terminal.

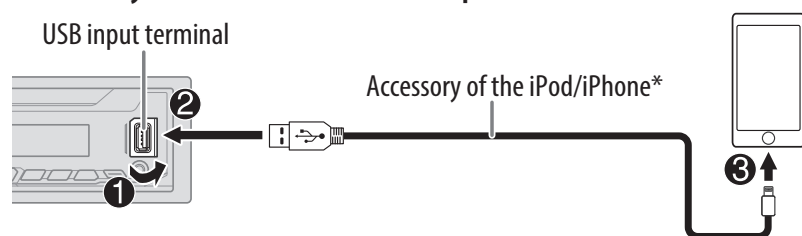

- 3 Press **SRC** repeatedly to select SPOTIFY.  
Broadcast starts automatically

\* Do not leave the cable inside the car when not using.

| To                         | On the faceplate            | On the remote control |
|----------------------------|-----------------------------|-----------------------|
| Playback/pause             | Press the volume knob.      | Press                 |
| Skip a track               | Press *1 / .                | Press *1 / .          |
| Thumbs up or thumbs down*2 | Press <b>2</b> / <b>1</b> . | Press  / .            |
| Start radio                | Press and hold <b>5</b> .   | ( Not available )     |

| To            | On the faceplate  | On the remote control |
|---------------|---|-----------------------|
| Repeat play*3 | Press <b>4</b> repeatedly.<br>ALL REPEAT, ONE REPEAT*1,<br>REPEAT OFF | ( Not available )     |
| Random play*3 | Press <b>3</b> repeatedly.*1<br>ALL RANDOM, RANDOM OFF                | ( Not available )     |

\*1 Available for premium account users only.

\*2 This feature is available for tracks in Radio only. If thumbs down is selected, the current track is skipped.

\*3 Available for tracks in Playlists only.

## Save favorite song information

While listening to the Radio on Spotify...

**Press and hold the volume knob.**

"SAVED" appears and the information is stored to "Your Music" or "Your Library" on your Spotify account.

To unsave, repeat the same procedure.

"REMOVED" appears and the information is removed from "Your Music" or "Your Library" on your Spotify account.

## Search for a song or station

- 1 Press **Q** / .
- 2 Turn the volume knob to select a list type, then press the knob.  
The list types displayed differ depending on the information sent from Spotify.
- 3 Turn the volume knob to select the desired song or station, then press the knob.  
You can browse through the list quickly by turning the volume knob quickly.

To cancel, press and hold **Q** / .

# SiriusXM® Radio (for KD-X350BTS/KD-X35MBS)

Only SiriusXM® brings you more of what you love to listen to, all in one place. Get over 140 channels, including commercial-free music plus the best sports, news, talk, comedy and entertainment. Welcome to the world of satellite radio. A SiriusXM Vehicle Tuner and Subscription are required. For more information, visit <www.siriusxm.com>.

## Preparation:

- 1 Connect the optional SiriusXM Vehicle Tuner (commercially available).

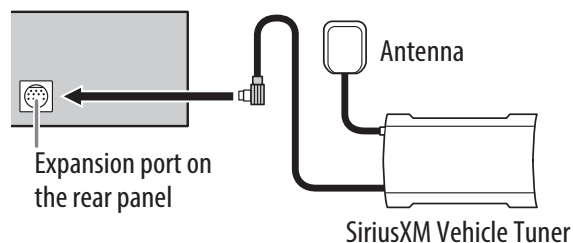

- 2 Check your Radio ID for activation.  
The SiriusXM Radio ID is required for activation and can be found by tuning to Channel 0 as well as on the label found on the SiriusXM Vehicle Tuner and its packaging.  
The Radio ID does not include the letters I, O, S or F.
- 3 Activate the subscription.  
For users in the U.S.A.:  
Online: Go to <www.siriusxm.com>  
Phone: Call 1-866-635-2349  
For users in Canada:  
Online: Go to <www.siriusxm.ca/activatexm>  
Phone: Call 1-877-438-9677
- 4 Press **SRC** repeatedly to select SIRIUS XM to start updating.

## Start listening

- 1 Press **SRC** repeatedly to select SIRIUS XM.
- 2 Press **Q** / **↵**.  
"Q" lights up.
- 3 Turn the volume knob to select a CATEGORY, then press the knob.
- 4 Turn the volume knob to select a category from the list, then press the knob.  
If "ALL CHANNEL" is selected, all the available channels will be shown.
- 5 Turn the volume knob to select a channel, then press the knob.  
(or)  
Press **◀◀** / **▶▶** to search for a channel manually.
  - Pressing and holding **◀◀** / **▶▶** changes the channel rapidly.

If a locked channel or a mature channel is selected, a pass code input screen appears. Enter the pass code to receive the channel. (→ 14)

## Settings in memory

You can store up to 18 channels.

### Store a channel

While listening to a channel...

Press and hold one of the number buttons (1 to 6).

(or)

- 1 Press and hold the volume knob until "PRESET MODE" flashes.
- 2 Turn the volume knob to select a preset number, then press the knob.  
The preset number flashes and "MEMORY" appears.

### Select a stored channel

Press one of the number buttons (1 to 6).

(or)

- 1 Press **Q** / **↵**.
- 2 Turn the volume knob to select PRESET, then press the knob.
- 3 Turn the volume knob to select a preset number, then press the knob.

Press **▲** / **▼** on the remote control.















## SiriusXM® Radio (for KD-X350BTS/KD-X35MBS)

### SiriusXM Replay™

While listening to a channel....

- 1 Press the volume knob.**  
"⏮" lights up and the unit memorizes this paused position.
- 2 Press the volume knob to start Replay.**  
Replay starts from the paused position in step 1.

During Replay...

| To                            | On the faceplate   | On the remote control  |
|-------------------------------|--|--|
| Playback/pause                | Press the volume knob.   | Press  .  |
| Skip backward/<br>forward     | Press   .  | Press   .          |
| Rewind/Fast-forward           | Press and hold   .   | Press and hold   . |
| Go to Live and exit<br>Replay | Press and hold the<br>volume knob.<br><br><b>1</b> Press  /  .<br><b>2</b> Turn the volume knob<br>to select LIVE, then<br>press the knob. | Press and hold  .   |

### SmartFavorites and TuneStart™

User preset channels are initially assigned as the SmartFavorites channels. SmartFavorite channel is available with SXV200 or later SiriusXM tuner models. The SiriusXM Vehicle Tuner automatically buffers the broadcast audio content of the SmartFavorites channels in the background.





**Using SXV200:** This unit can assign a maximum of 6 SmartFavorites channels. If you try to assign the 7th channel, an error beep tone will be heard. Initially, preset channels 1 to 6 are assigned as SmartFavorites.

**Using SiriusXM tuner models later than SXV200:** This unit can assign a maximum of 18 SmartFavorites channels. Initially, all preset channels are assigned as SmartFavorites.

- "\*" appears at the last character of the channel name for the SmartFavorites channels.

When you select a SmartFavorite channel, you can rewind and replay up to 30 minutes of any of the missed news, talk, sports or music content.

- Playback starts from the beginning of the song if [TUNE START] is set to [ON] (→ 14) for most music channels stored as a SmartFavorite.

| To  | On the faceplate  |
|---|---|
| Select a stored<br>SmartFavorite<br>channel | Press one of the number buttons (1 to 6).<br><br><b>1</b> Press  /  .<br><b>2</b> Turn the volume knob to select PRESET, then<br>press the knob.<br><b>3</b> Turn the volume knob to select a preset<br>number, then press the knob.    |
| Cancel<br>SmartFavorites<br>channels        | <b>1</b> Press  /  .<br><b>2</b> Turn the volume knob to select PRESET, then<br>press the knob.<br><b>3</b> Turn the volume knob to select a preset<br>number, then press and hold the knob.<br>"*" is removed from the last character. |
| Reassign<br>SmartFavorites<br>channels      | Repeat steps 1 to 3 of cancelling SmartFavorites<br>channels.<br>"*" appears at the last character.   |

## SiriusXM® Radio (for KD-X350BTS/KD-X35MBS)

### TuneScan™

You can get a short preview of the songs that you have missed on each of your SmartFavorites music channels or currently tuned music channel.

- 1 Press **Q** / **↵**.
- 2 Turn the volume knob to select **TUNE SCAN**, then press the knob.  
Scanning start for the first 6 seconds of the recorded music contents.
  - To listen to the current song, press the volume knob to stop scanning. The unit continues playing the current song.
  - To select the previous/next song, press **◀◀** / **▶▶**.
  - To cancel scanning, press and hold the volume knob. Playback returns to the channel before you entered TuneScan.

### SiriusXM settings

- 1 Press and hold **☰** · **⚙**.
- 2 Turn the volume knob to select an item (see the following table), then press the knob.
- 3 Repeat step 2 until the desired item is selected/activated or follow the instructions stated on the selected item.
- 4 Press **☰** · **⚙** to exit.

To return to the previous setting item, press **Q** / **↵**.

Default: **XX**

### SIRIUS XM

- CHANNEL LOCK** To unlock settings:
- 1 Turn the volume knob to select a number.
  - 2 Press **◀◀** / **▶▶** to move to the entry position.
  - 3 Repeat steps 1 and 2 to enter the current pass code.  
(Initial pass code is 0000.)
  - 4 Press the volume knob to confirm.

|                         |   |
|-------------------------|---|
| <b>CODE SET</b>         | <ol style="list-style-type: none"> <li>1 Press the volume knob to enter <b>[NEW CODE]</b>.</li> <li>2 Turn the volume knob to select a number.</li> <li>3 Press <b>◀◀</b> / <b>▶▶</b> to move to the entry position.</li> <li>4 Repeat steps 2 and 3 to enter a new 4-digit pass code.</li> <li>5 Press the volume knob to confirm.</li> <li>6 Repeat steps 2 to 5 to reconfirm the pass code.           <ul style="list-style-type: none"> <li>• Make a note of the new pass code to enter channel lock settings for next time.</li> </ul> </li> </ol> |
| <b>LOCK SETTING</b>     | <b>MATURE CH:</b> Selects the SiriusXM-defined lock setting. ;<br><b>USER DEFINED:</b> Selects the individual channels the user wants to lock. ; <b>OFF:</b> Cancels.   |
| <b>CHANNEL EDIT</b> *1  | <ol style="list-style-type: none"> <li>1 Turn the volume knob to select a category, then press the knob.</li> <li>2 Turn the volume knob to select a channel you want to lock, then press the knob.<br/>“L” appears in front of the channel number.</li> <li>3 Press and hold <b>Q</b> / <b>↵</b> to exit.</li> </ol>   |
| <b>CHANNEL CLEAR</b> *1 | <b>YES:</b> Clears all the locked channels. ; <b>NO:</b> Cancels.   |
| <b>TUNE START</b> *2    | <b>ON:</b> All qualified music channels in the SmartFavorites will start playback from the beginning of the song. ; <b>OFF:</b> Cancels.  |
| <b>SIGNAL LEVEL</b>     | Shows the strength ( <b>NO SIGNAL/WEAK/GOOD/STRONG</b> ) of the current received signal.  |
| <b>BUFFER USAGE</b>     | Shows the memory usage ( <b>0% to 100%</b> ) for Replay buffer.   |
| <b>SXM RESET</b>        | <b>YES:</b> Resets stored channel and lock setting to default. ; <b>NO:</b> Cancels.  |

\*1 Displayed only when **[USER DEFINED]** is selected.

\*2 Available only if the connected SiriusXM Vehicle Tuner is SXV200 or later that supports SmartFavorites.

# BLUETOOTH®

## BLUETOOTH — Connection

### Supported Bluetooth profiles

- Hands-Free Profile (HFP)
- Advanced Audio Distribution Profile (A2DP)
- Audio/Video Remote Control Profile (AVRCP)
- Serial Port Profile (SPP)
- Phonebook Access Profile (PBAP)

### Supported Bluetooth codecs

- Sub Band Codec (SBC)
- Advanced Audio Coding (AAC)

## Connect the microphone

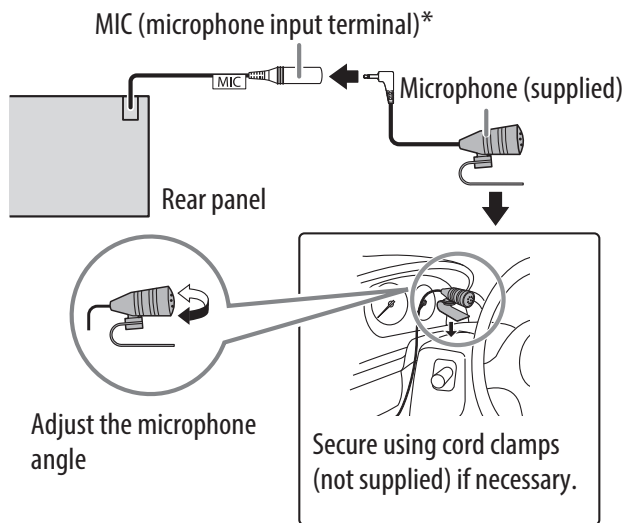

\* For the location of the microphone input terminal/microphone input jack, refer to page 40.

## Pair and connect a Bluetooth device for the first time

- 1 Press **⏻SRC** to turn on the unit.
- 2 Search and select **"KD-X3\*BT"/"KD-X2\*BT"/"KD-X3\*MBS"** on the Bluetooth device. "BT PAIRING" flashes on the display.
  - For some Bluetooth devices, you may need to enter the Personal Identification Number (PIN) code immediately after searching.
- 3 Perform (A) or (B) depending on what appears on the display. For some Bluetooth devices, pairing sequence may vary from the steps described below.
  - (A) "[Device Name]" → "XXXXXX" → "VOL – YES" → "BACK – NO"  
"XXXXXX" is a 6-digit passkey randomly generated during each pairing.
    - 1 Ensure that the passkeys appear on the unit and Bluetooth device are the same.
    - 2 Press the volume knob to confirm the passkey.
    - 3 Operate the Bluetooth device to confirm the passkey.
  - (B) "[Device Name]" → "VOL – YES" → "BACK – NO"
    - 1 Press the volume knob to start pairing.
    - 2
      - If "PAIRING" → "PIN 0000" scrolls on the display, enter the PIN code "0000" into the Bluetooth device.  
You can change to a desired PIN code before pairing. (→ 19)
      - If only "PAIRING" appears, operate the Bluetooth device to confirm pairing."PAIRING COMPLETED" appears when pairing is completed and **Ⓜ** will light up when the Bluetooth connection is established.
  - This unit supports Secure Simple Pairing (SSP).
  - Up to five devices can be registered (paired) in total.
  - Once the pairing is completed, the Bluetooth device will remain registered in the unit even if you reset the unit. To delete the paired device, → 19, [DEVICE DELETE].
  - A maximum of two Bluetooth phones and one Bluetooth audio device can be connected at any time.  
However, while in BT AUDIO source, you can connect to five Bluetooth audio devices and switch between these five devices. (→ 20)
  - Some Bluetooth devices may not automatically connect to the unit after pairing. Connect the device to the unit manually.
  - Refer to the instruction manual of the Bluetooth device for more information.

# BLUETOOTH®

## Auto Pairing

When you connect the iPhone/iPod touch/Android device to the USB input terminal, pairing request (via Bluetooth) is automatically activated.

Press the volume knob to pair once you have confirmed the device name.

Automatic pairing request is activated only if:

- Bluetooth function of the connected device is turned on.
- [AUTO PAIRING] is set to [ON]. (⇒ 19)
- JVC MUSIC PLAY application is installed on the Android device (⇒ 7) and [AUTO MODE] is selected (⇒ 8).

## BLUETOOTH — Mobile phone

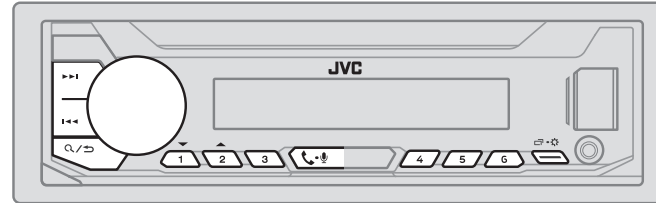

## Receive a call

When there is an incoming call:

- **KD-X350BTS/KD-X35MBS:**  
The buttons will blink in the color you have selected in [RING COLOR]. (⇒ 17)
- **KD-X255BT:**  
The buttons will blink in the blinking pattern you have selected in [RING ILLUMI]. (⇒ 17)
- The unit answers the call automatically if [AUTO ANSWER] is set to a selected time. (⇒ 17)

During a call:

- **KD-X350BTS/KD-X35MBS:**  
The buttons stop blinking and illuminate in the color you have selected in [RING COLOR]. (⇒ 17)
- **KD-X255BT:**  
The buttons stop blinking.
- If you turn off the unit or detach the faceplate, the Bluetooth connection is disconnected.

The following operations may differ or not available depending on the connected phone.

| To                     | On the faceplate                       | On the remote control     |
|------------------------|--|---------------------------|
| First incoming call... |  |                           |
| Answer a call          | Press  -  or the volume knob.          | Press  /  /  / .          |
| Reject a call          | Press and hold  -  or the volume knob. | Press and hold  /  /  / . |
| End a call             | Press and hold  -  or the volume knob. | Press and hold  /  /  / . |

## BLUETOOTH®

| To   | On the faceplate                       | On the remote control  |
|--|--|--|
| While talking on the first incoming call...                        |  |  |
| Answer another incoming call and hold the current call             | Press  -  or the volume knob.          | ( Not available )  |
| Reject another incoming call                                       | Press and hold  -  or the volume knob. | ( Not available )  |
| While having two active calls...                                   |  |  |
| End current call and activate held call                            | Press and hold  -  or the volume knob. | Press and hold  /  /  / .  |
| Swap between the current call and held call                        | Press  - .                             | ( Not available )  |
| Adjust the phone volume* <sup>1</sup> [00] to [35] (Default: [15]) | Turn the volume knob during a call.    | Press <b>VOL +</b> * <sup>2</sup> or <b>VOL -</b> during a call. |
| Switch between hands-free and private talk modes* <sup>3</sup>     | Press  /  during a call.               | ( Not available )  |

\*<sup>1</sup> This adjustment will not affect the volume of the other sources.

\*<sup>2</sup> Press and hold **VOL +** to continuously increase the volume to 15.

\*<sup>3</sup> Operations may vary according to the connected Bluetooth device.

### ■ Improve the voice quality

While talking on the phone...

- 1 Press and hold · .
- 2 Turn the volume knob to select an item (see the following table), then press the knob.
- 3 Repeat step 2 until the desired item is selected or activated.
- 4 Press · to exit.

To return to the previous setting item, press / .

Default: **XX**

|             |   |
|-------------|---|
| MIC GAIN    | LEVEL -10 to LEVEL +10 (LEVEL -04): The sensitivity of the microphone increases as the number increased.                                    |
| NR LEVEL    | LEVEL -05 to LEVEL+05 (LEVEL 00): Adjust the noise reduction level until the least noise is being heard during a phone conversation.        |
| ECHO CANCEL | LEVEL -05 to LEVEL +05 (LEVEL 00): Adjust the echo cancellation delay time until the least echo is being heard during a phone conversation. |

### ■ Make the settings for receiving a call

- 1 Press - to enter Bluetooth mode.
- 2 Turn the volume knob to select an item (see the following table), then press the knob.
- 3 Repeat step 2 until the desired item is selected or activated.

To return to the previous setting item, press / .

Default: **XX**

| SETTINGS     |  |
|--------------|--|
| AUTO ANSWER  | 01 SEC to 30 SEC: The unit answers incoming call automatically in the selected time (in seconds). ; <b>OFF</b> : Cancels.  |
| RING COLOR   | KD-X350BTS/KD-X35MBS:<br>COLOR 01 to COLOR 49 (COLOR 08): Selects the illumination color for the buttons as notification when there is an incoming call and during a call. ; <b>OFF</b> : Cancels. |
| RING ILLUMI  | KD-X255BT:<br>BLINK 01 to BLINK 05 (BLINK 02): Selects the blinking pattern for the buttons as notification when there is an incoming call. ; <b>OFF</b> : Cancels.                                |
| BATT/SIGNAL* | KD-X350BTS/KD-X35MBS:<br>AUTO: Shows the strength of the battery and signal when the unit detects a Bluetooth device and the Bluetooth device is connected. ; <b>OFF</b> : Cancels.                |

\* Functionality depends on the type of the phone used.

## BLUETOOTH®

### Make a call

You can make a call from the call history, phonebook, or dialing the number. Call by voice is also possible if your mobile phone has the feature.

- 1 Press - to enter Bluetooth mode.  
“(First device name)” appears.
  - If two Bluetooth phones are connected, press - again to switch to another phone.  
“(Second device name)” appears.
- 2 Turn the volume knob to select an item (see the following table), then press the knob.
- 3 Repeat step 2 until the desired item is selected/activated or follow the instructions stated on the selected item.

To return to the previous setting item, press / .

|                    |   |
|--------------------|---|
| <b>RECENT CALL</b> | (Applicable only if the phone supports PBAP.) <ol style="list-style-type: none"><li>1 Press the volume knob to select a name or a phone number.<ul style="list-style-type: none"><li>• “&lt;” indicates call received, “&gt;” indicates call made, “M” indicates call missed.</li><li>• “NO HISTORY” appears if there is no recorded call history or call number.</li></ul></li><li>2 Press the volume knob to call.</li></ol>  |
| <b>PHONEBOOK</b>   | (Applicable only if the phone supports PBAP.) <ol style="list-style-type: none"><li>1 Press <b>2 ▲</b> / <b>1 ▼</b> to select the desired letter (A to Z, 0 to 9, and OTHERS).<ul style="list-style-type: none"><li>• “OTHERS” appears if the first character is other than A to Z, 0 to 9.</li></ul></li><li>2 Turn the volume knob to select a name, then press the knob.</li><li>3 Turn the volume knob to select a phone number, then press the knob to call.<ul style="list-style-type: none"><li>• The phonebook of the connected phone is automatically transferred to the unit when pairing.</li><li>• This unit can display only non-accent letters. (Accent letters such as “Ú” is shown as “U”.)</li></ul></li></ol> |
| <b>DIAL NUMBER</b> | <ol style="list-style-type: none"><li>1 Turn the volume knob to select a number (0 to 9) or character (*, #, +).</li><li>2 Press  /  to move the entry position.<br/>Repeat steps 1 and 2 until you finish entering the phone number.</li><li>3 Press the volume knob to call.</li></ol>  |
| <b>VOICE</b>       | Speak the name of the contact you want to call or the voice command to control the phone functions. (➔ <b>Make a call using voice recognition</b> )   |

### Make a call using voice recognition

- 1 Press and hold - to activate the connected phone.
- 2 Speak the name of the contact you want to call or the voice command to control the phone functions.
  - Supported Voice Recognition features vary for each phone. Refer to the instruction manual of the connected phone for details.
  - This unit also supports the intelligent personal assistant function of iPhone.

### Settings in memory

#### Store a contact in memory

You can store up to 6 contacts into the number buttons (1 to 6).

- 1 Press - to enter Bluetooth mode.
- 2 Turn the volume knob to select [RECENT CALL], [PHONEBOOK] or [DIAL NUMBER], then press the knob.
- 3 Turn the volume knob to select a contact or enter a phone number.  
If a contact is selected, press the volume knob to show the phone number.
- 4 Press and hold one of the number buttons (1 to 6).  
“MEMORY P(selected preset number)” appears when the contact is stored.

To erase a contact from the preset memory, select [DIAL NUMBER] in step 2 and store a blank number.

#### Make a call from memory

- 1 Press - to enter Bluetooth mode.
- 2 Press one of the number buttons (1 to 6).
- 3 Press the volume knob to call.  
“NO PRESET” appears if there is no contact stored.

# BLUETOOTH®

## Bluetooth mode settings

- 1 Press and hold .
- 2 Turn the volume knob to select an item (see the following table), then press the knob.
- 3 Repeat step 2 until the desired item is selected/activated or follow the instructions stated on the selected item.
- 4 Press to exit.

To return to the previous setting item, press / .

Default: **XX**

| BT MODE                     |   |
|-----------------------------|---|
| <b>PHONE SELECT*</b>        | Selects the phone or audio device to connect or disconnect.<br>“*” appears in front of the device name when connected.  |
| <b>AUDIO SELECT*</b>        | “▷” appears in front of the current playback audio device.  |
| <b>DEVICE DELETE</b>        | <ol style="list-style-type: none"> <li>1 Turn the volume knob to select a device to delete, then press the knob.</li> <li>2 Turn the volume knob to select <b>[YES]</b> or <b>[NO]</b>, then press the knob.</li> </ol>   |
| <b>PIN CODE EDIT (0000)</b> | <p>Changes the PIN code (up to 6 digits).</p> <ol style="list-style-type: none"> <li>1 Turn the volume knob to select a number.</li> <li>2 Press  /  to move the entry position.<br/>Repeat steps 1 and 2 until you finish entering the PIN code.</li> <li>3 Press the volume knob to confirm.</li> </ol> |
| <b>RECONNECT</b>            | <p><b>ON:</b> The unit automatically reconnect when the last connected Bluetooth device is within range. ;</p> <p><b>OFF:</b> Cancels.</p>  |
| <b>AUTO PAIRING</b>         | <p><b>ON:</b> The unit automatically pair supported Bluetooth device (iPhone/iPod touch/Android device) when it is connected through USB input terminal. Depending on the operating system of the connected device, this function may not work. ;</p> <p><b>OFF:</b> Cancels.</p>                         |
| <b>INITIALIZE</b>           | <p><b>YES:</b> Initializes all the Bluetooth settings (including stored pairing, phonebook, and etc.). ;</p> <p><b>NO:</b> Cancels.</p>   |
| <b>INFORMATION</b>          | <p><b>MY BT NAME:</b> Displays the unit name (“KD-X3*×*BTS”/“KD-X2*×*BT”/“KD-X3*×*MBS”). ;</p> <p><b>MY ADDRESS:</b> Shows address of this unit.</p>  |

\* You can only connect a maximum of two Bluetooth phones and one Bluetooth audio device at any time.

## Bluetooth compatibility check mode

You can check the connectivity of the supported profile between the Bluetooth device and the unit.

- Make sure there is no Bluetooth device paired.

- 1 Press and hold - .
- “BLUETOOTH” ↔ “CHECK MODE” appears.  
“SEARCH NOW USING PHONE” → “PIN IS 0000” scrolls on the display.
- 2 Search and select “KD-X3\*×\*BTS”/“KD-X2\*×\*BT”/“KD-X3\*×\*MBS” on the Bluetooth device within 3 minutes.
- 3 Perform (A), (B) or (C) depending on what appears on the display.
  - (A) “PAIRING” → “XXXXXX” (6-digit passkey):  
Ensure that the same passkey appears on the unit and Bluetooth device, then operate the Bluetooth device to confirm the passkey.
  - (B) “PAIRING” → “PIN IS 0000”: Enter “0000” on the Bluetooth device.
  - (C) “PAIRING”: Operate the Bluetooth device to confirm pairing.

After pairing is successful, “PAIRING OK” → “[Device Name]” appears and Bluetooth compatibility check starts.

If “CONNECT NOW USING PHONE” appears, operate the Bluetooth device to allow phonebook access to continue.

“TESTING” flashes on the display.



## BLUETOOTH®

The connectivity result flashes on the display. "PAIRING OK" and/or "HANDS-FREE OK"\*1 and/or "AUD.STREAM OK"\*2 and/or "PBAP OK"\*3 : Compatible

\*1 Compatible with Hands-Free Profile (HFP)

\*2 Compatible with Advanced Audio Distribution Profile (A2DP)

\*3 Compatible with Phonebook Access profile (PBAP)

After 30 seconds, "PAIRING DELETED" appears to indicate that pairing has been deleted, and the unit exits check mode.

- To cancel, press and hold **SRC** to turn off the power, then turn on the power again.

### BLUETOOTH — Audio

While in BT AUDIO source, you can connect to five Bluetooth audio devices and switch between these five devices.

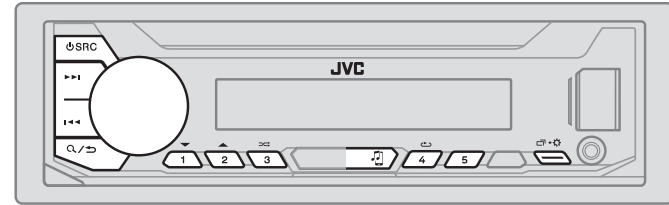

#### Audio player via Bluetooth

- Press **SRC** repeatedly to select BT AUDIO (or press **SOURCE** on the remote control).
  - Pressing **BT** enters BT AUDIO directly.
- Operate the Bluetooth audio player to start playback.

| To   | On the faceplate   | On the remote control         |
|--|--|-------------------------------|
| Playback/pause                                   | Press the volume knob.   | Press <b>⏮</b> .              |
| Select group or folder                           | Press <b>2 ▲ / 1 ▼</b> .   | Press <b>▲ / ▼</b> .          |
| Reverse skip/Forward skip                        | Press <b>⏮ / ⏭</b> .   | Press <b>◀ / ▶</b> .          |
| Reverse/Fast-forward                             | Press and hold <b>⏮ / ⏭</b> .  | Press and hold <b>◀ / ▶</b> . |
| Repeat play                                      | Press <b>4 ↺</b> repeatedly.<br>TRACK REPEAT, ALL REPEAT, REPEAT OFF | ( Not available )             |
| Random play                                      | Press <b>3 ↻</b> repeatedly.<br>GROUP RANDOM, ALL RANDOM, RANDOM OFF | ( Not available )             |
| Select a file from a folder/list                 | Refer to "Select a file from a folder/list" on page 8.               | ( Not available )             |
| Switch between connected Bluetooth audio devices | Press <b>5.*</b>   | ( Not available )             |

\* Pressing the "Play" key on the connected device itself also causes switching of sound output from the device.

Operations and display indications may differ according to their availability on the connected device.







# BLUETOOTH®

## Settings to use JVC Remote application

JVC Remote application is designed to control the JVC car receiver's operations from the iPhone/iPod (via Bluetooth or via USB input terminal) or Android smartphone (via Bluetooth).

### Preparation:

Install the latest version of JVC Remote application on your device before connecting. For more information, visit <<http://www.jvc.net/cs/car/>>.

- 1 Press and hold  .
- 2 Turn the volume knob to select an item (see the following table), then press the knob.
- 3 Repeat step 2 until the desired item is selected or activated.
- 4 Press   to exit.

To return to the previous setting item, press .

Default: **XX**

| REMOTE APP           |   |
|----------------------|---|
| <b>SELECT</b>        | Select the device (IOS or ANDROID) to use the application.  |
| <b>IOS</b>           | <b>YES:</b> Selects iPhone/iPod to use the application via Bluetooth or connected via USB input terminal. ; <b>NO:</b> Cancels.<br>If IOS is selected, select iPod BT source (or iPod USB if your iPhone/iPod is connected via USB input terminal) to activate the application. <ul style="list-style-type: none"><li>• The connectivity of the application will be interrupted or disconnected if:<ul style="list-style-type: none"><li>– You change from iPod BT source to any playback source connected via the USB input terminal.</li><li>– You change from iPod USB source to iPod BT source.</li></ul></li></ul> |
| <b>ANDROID</b>       | <b>YES:</b> Selects Android smartphone to use the application via Bluetooth. ;<br><b>NO:</b> Cancels.   |
| <b>ANDROID LIST*</b> | Selects the Android smartphone to use from the list.  |

\* Displayed only when [ANDROID] of [SELECT] is set to [YES].

## STATUS

Shows the status of the selected device.

**IOS CONNECTED:** You are able to use the application using the iPhone/iPod connected via Bluetooth or USB input terminal.

**IOS NOT CONNECTED:** No IOS device is connected to use the application.

**ANDROID CONNECTED:** You are able to use the application using the Android smartphone connected via Bluetooth.

**ANDROID NOT CONNECTED:** No Android device is connected to use the application.

## Listen to iPhone/iPod via Bluetooth

You can listen to the songs on the iPhone/iPod via Bluetooth on this unit.

Press  repeatedly to select iPod BT.

- You can operate the iPod/iPhone in the same way as iPod/iPhone via USB input terminal. (→ 7)
- If you plug in an iPhone/iPod to the USB input terminal while listening to iPod BT source, the source automatically change to iPod USB. Press  to select iPod BT if the device is still connected via Bluetooth.

## BLUETOOTH®

---

### Internet radio via Bluetooth

You can listen to internet radio (Pandora, iHeartRadio and Spotify) on the iPhone/iPod touch/Android device via Bluetooth on this unit.

- Make sure the USB input terminal is not connected to any device.

### ■ Listen to Pandora

#### Preparation:

Select [ON] for [PANDORA SRC] in [SOURCE SELECT]. (→ 4)

- 1 Open the Pandora application on your device.
- 2 Connect your device via Bluetooth connection. (→ 15)
- 3 Press **⏻SRC** repeatedly to select PANDORA (for iPhone/iPod) or PANDORA BT (for Android device).

The source switches and broadcast starts automatically.

- You can operate Pandora in the same way as Pandora via USB input terminal. (→ 9)

### ■ Listen to iHeartRadio

#### Preparation:

Select [ON] for [IHEART SRC] in [SOURCE SELECT]. (→ 4)

- 1 Open the iHeartAuto application on your device.
- 2 Connect your device via Bluetooth connection. (→ 15)
- 3 Press **⏻SRC** repeatedly to select IHEARTRADIO.

The source switches and broadcast starts automatically.

- You can operate iHeartRadio in the same way as iHeartRadio via USB input terminal. (→ 10)

### ■ Listen to Spotify

#### Preparation:

Select [ON] for [SPOTIFY SRC] in [SOURCE SELECT]. (→ 4)

- 1 Open the Spotify application on your device.
- 2 Connect your device via Bluetooth connection. (→ 15)
- 3 Press **⏻SRC** repeatedly to select SPOTIFY (for iPhone/iPod) or SPOTIFY BT (for Android device).

The source switches and broadcast starts automatically.

- You can operate Spotify in the same way as Spotify via USB input terminal. (→ 11)

# AUX

## Use a portable audio player

- 1 Connect a portable audio player (commercially available).

3.5 mm (1/8") stereo mini plug with "L" shaped connector (commercially available)

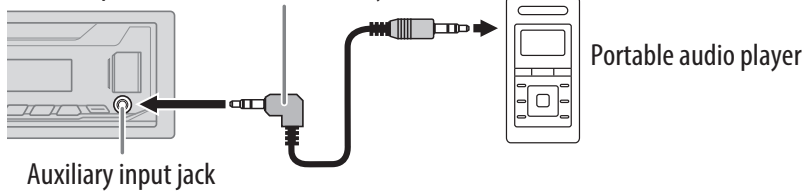

- 2 Select [ON] for [BUILT-IN AUX] in [SOURCE SELECT]. (→ 4)
- 3 Press **SRC** repeatedly to select AUX.
- 4 Turn on the portable audio player and start playback.

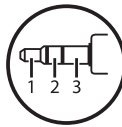

Use a 3-core plug head stereo mini plug for optimum audio output.

# AUDIO SETTINGS

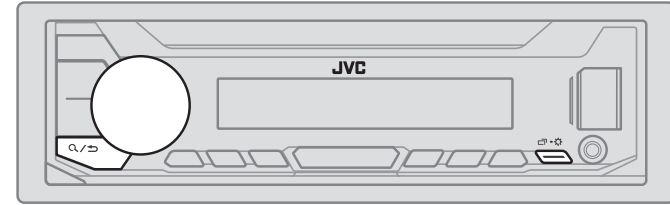

- 1 Press and hold **EQ/SC**.
- 2 Turn the volume knob to select an item (see the following table), then press the knob.
- 3 Repeat step 2 until the desired item is selected/activated or follow the instructions stated on the selected item.
- 4 Press **EQ/SC** to exit.

To return to the previous setting item, press **Q/↵**.

Default: **XX**

## EQ SETTING

### PRESET EQ

Select a preset equalizer suitable to the music genre.

- Select [USER] to use the settings made in [EASY EQ] or [PRO EQ].

**FLAT/DRVN 3/DRVN 2/DRVN 1/HARD ROCK/HIP HOP/JAZZ/POP/R&B/USER/CLASSICAL**

Drive equalizer (**DRVN 3/DRVN 2/DRVN 1**) boosts specific frequencies in the audio signal to reduce the noise heard from outside the car or running noise of the tyres.

### EASY EQ

Adjust your own sound settings.

- The settings are stored to [USER].
- The settings made may affect the current settings of [PRO EQ].

**SUB.W SP\*1\*2:** **00 to +06** (Default: **+03**)

**SUB.W\*1\*3:** **-50 to +10** **00**

**BASS:** **LVL-09 to LVL+09** **LVL 00**

**MID:** **LVL-09 to LVL+09** **LVL 00**

**TRE:** **LVL-09 to LVL+09** **LVL 00**

\*1, \*2, \*3: (→ 24)

## AUDIO SETTINGS

|   |  |
|---|--|
| <b>PRO EQ</b>   | Adjust your own sound settings.<br>• The settings are stored to [USER].<br>• The settings made may affect the current settings of [EASY EQ].   |
| <b>62.5HZ</b>   | <b>LEVEL -09 to LEVEL +09 (LEVEL 00):</b> Adjusts the level to memorize for each source. (Before making an adjustment, select the source you want to adjust.)<br><b>ON:</b> Turns on the extended bass. ; <b>OFF:</b> Cancels. |
| <b>100HZ/160HZ/250HZ/400HZ/630HZ/1KHZ/1.6KHZ/2.5KHZ/4KHZ/6.3KHZ/10KHZ/16kHZ</b> | <b>LEVEL -09 to LEVEL +09 (LEVEL 00):</b> Adjusts the level to memorize for each source. (Before making an adjustment, select the source you want to adjust.)  |
| <b>Q FACTOR</b>   | <b>1.35/1.50/2.00:</b> Adjust the quality factor.  |
| <b>AUDIO CONTROL</b>  |  |
| <b>BASS BOOST</b>   | <b>LEVEL +01 to LEVEL +05:</b> Selects your preferred bass boost level. ; <b>OFF:</b> Cancels.   |
| <b>LOUDNESS</b>   | <b>LEVEL 01/LEVEL 02:</b> Boosts low or high frequencies to produce a well-balanced sound at low volume. ; <b>OFF:</b> Cancels   |
| <b>SUB.W LEVEL *1</b>   | <b>SPK-OUT*2</b> (Not applicable when 3-way crossover is selected.)<br><b>SUB.W 00 to SUB.W +06 (SUB.W +03):</b> Adjusts the output level of the subwoofer connected via speaker lead. (➔ 39)                                  |
|   | <b>PRE-OUT*3</b> <b>SUB.W -50 to SUB.W +10 (SUB.W 00):</b> Adjusts the output level of the subwoofer connected to the lineout terminals (SW or REAR/SW) through an external amplifier. (➔ 40)                                  |
| <b>SUBWOOFER SET*3</b>  | <b>ON:</b> Turns on the subwoofer output. ; <b>OFF:</b> Cancels.   |
| <b>FADER</b>  | (Not applicable when 3-way crossover is selected.)<br><b>POSITION R15 to POSITION F15 (POSITION 00):</b> Adjusts the front and rear speaker output balance.  |

|                      |  |
|----------------------|--|
| <b>BALANCE*4</b>     | <b>POSITION L15 to POSITION R15 (POSITION 00):</b> Adjusts the left and right speaker output balance.  |
| <b>VOLUME ADJUST</b> | <b>LEVEL -15 to LEVEL +06 (LEVEL 00):</b> Preset the initial volume level of each source (compared to the FM volume level). Before adjustment, select the source you want to adjust.                                       |
| <b>AMP GAIN</b>      | <b>LOW POWER:</b> Limits the maximum volume level to 25. (Select if the maximum power of each speaker is less than 50 W to prevent damaging the speakers.) ; <b>HIGH POWER:</b> The maximum volume level is 35.            |
| <b>SPK/PRE OUT</b>   | (Not applicable when 3-way crossover is selected.)<br>Depending on the speaker connection method, select the appropriate setting to get the desired output. (➔ 25, <b>Speaker output settings</b> )                        |
| <b>SPEAKER SIZE</b>  | Depending on the crossover type you have selected (➔ [X ' OVER TYPE]), 2-way crossover or 3-way crossover setting items will be shown. (➔ 26, <b>Crossover settings</b> )<br>By default, 2-way crossover type is selected. |
| <b>X ' OVER</b>      |  |
| <b>DTA SETTINGS</b>  | For settings, ➔ 27, <b>Digital Time Alignment settings.</b>  |
| <b>CAR SETTINGS</b>  |  |
| <b>X ' OVER TYPE</b> | <b>Caution:</b> Adjust the volume before changing the [X ' OVER TYPE] to avoid the sudden increase or decrease of the output level.  |
| <b>2-WAY</b>         | (Displayed only when [3-WAY] is selected)<br><b>YES:</b> Selects two way crossover type. ; <b>NO:</b> Cancels.   |
| <b>3-WAY</b>         | (Displayed only when [2-WAY] is selected)<br><b>YES:</b> Selects three way crossover type. ; <b>NO:</b> Cancels.   |

\*1 Displayed only when [SUBWOOFER SET] is set to [ON].

\*2 For 2-way crossover: Displayed only when [SPK/PRE OUT] is set to [SUB.W/SUB.W]. (➔ 25)

\*3 For 2-way crossover: Displayed only when [SPK/PRE OUT] is set to [REAR/SUB.W] or [SUB.W/SUB.W]. (➔ 25)

\*4 This adjustment will not affect the subwoofer output.

## AUDIO SETTINGS

| SOUND EFFECT         |   |
|----------------------|---|
| <b>SPACE ENHANCE</b> | (Not applicable for TUNER source.)<br><b>SMALL/MEDIUM/LARGE:</b> Virtually enhances the sound space. ;<br><b>OFF:</b> Cancels.                          |
| <b>SND RESPONSE</b>  | <b>LEVEL1/LEVEL2/LEVEL3:</b> Virtually makes the sound more realistic. ;<br><b>OFF:</b> Cancels.  |
| <b>SOUND LIFT</b>    | <b>LOW/MIDDLE/HIGH:</b> Virtually adjust the sound position heard from the speakers. ; <b>OFF:</b> Cancels.   |
| <b>VOL LINK EQ</b>   | <b>ON:</b> Boosts the frequency to reduce the noise heard from outside the car or running noise of the tyres. ; <b>OFF:</b> Cancels.                    |
| <b>K2 TECHNOLOGY</b> | (Not applicable for TUNER source, SIRIUS XM source and AUX source.)<br><b>ON:</b> Improve the sound quality of compressed music. ; <b>OFF:</b> Cancels. |

### Speaker output settings [SPK/PRE OUT]

(Applicable only if [X ' OVER TYPE] is set to [2-WAY]) (→ 24)

Select the output setting for the speakers [SPK/PRE OUT], based on the speaker connection method.

### Connection via lineout terminals

For connections through an external amplifier. (→ 40)

KD-X350BTS/KD-X35MBS:

| Setting on<br>[SPK/PRE OUT] | Audio signal through lineout terminal |   |                   |
|-----------------------------|---------------------------------------|---|-------------------|
|                             | FRONT                                 | REAR  | SW                |
| <b>REAR/REAR</b> (default)  | Front speakers output                 | Rear speakers output                            | Subwoofer output  |
| <b>REAR/SUB.W</b>           | ( Not available )                     | ( Not available )                               | ( Not available ) |
| <b>SUB.W/SUB.W</b>          | Front speakers output                 | L (left): Subwoofer output<br>R (right): (Mute) | Subwoofer output  |

KD-X255BT:

| Setting on<br>[SPK/PRE OUT] | Audio signal through lineout terminal |                      |
|-----------------------------|---------------------------------------|----------------------|
|                             | FRONT                                 | REAR/SW              |
| <b>REAR/REAR</b>            | Front speakers output                 | Rear speakers output |
| <b>REAR/SUB.W</b> (default) | Front speakers output                 | Subwoofer output     |
| <b>SUB.W/SUB.W</b>          | Front speakers output                 | Subwoofer output     |

### Connection via speaker leads

For connections without using an external amplifier. However, with this settings you can also enjoy the subwoofer output. (→ 39)

| Setting on<br>[SPK/PRE OUT] | Audio signal through rear speaker lead |                      |
|-----------------------------|--|----------------------|
|                             | L (left)                               | R (right)            |
| <b>REAR/REAR</b>            | Rear speakers output                   | Rear speakers output |
| <b>REAR/SUB.W</b>           | Rear speakers output                   | Rear speakers output |
| <b>SUB.W/SUB.W</b>          | Subwoofer output                       | (Mute)               |

If [SUB.W/SUB.W] is selected:

- [120HZ] is selected in [SUBWOOFER LPF] and [THROUGH] is not available.
- [POSITION R02] is selected in [FADER] and selectable range is [POSITION R15] to [POSITION 00].

## AUDIO SETTINGS

### Crossover settings

Below are the available setting items for 2-way crossover and 3-way crossover.

#### ▲ Caution

Select a crossover type according to how the speakers are connected. (➔ 39, 40)

If you select a wrong type:

- The speakers may damage.
- The output sound level may be extremely high or low.

#### SPEAKER SIZE

Selects according to the connected speaker size for optimum performance.

- The frequency and slope settings are automatically set for the crossover of the selected speaker.
- When 2-way crossover is selected, if [NONE] is selected for [TWEETER] of [FRONT], [REAR] and [SUBWOOFER] for [SPEAKER SIZE], the [X' OVER] setting of the selected speaker is not available.
- When 3-way crossover is selected, if [NONE] is selected for [WOOFER] of [SPEAKER SIZE], the [X' OVER] setting of [WOOFER] is not available.

#### X' OVER (crossover)

- [FRQ]/[F-HPF FRQ]/[R-HPF FRQ]/[SW LPF FRQ]/[HPF FRQ]/[LPF FRQ]: Adjusts the crossover frequency for the selected speakers (high pass filter or low pass filter).  
If [THROUGH] is selected, all signals are sent to the selected speakers.
- [SLOPE]/[F-HPF SLOPE]/[R-HPF SLOPE]/[SW LPF SLOPE]/[HPF SLOPE]/[LPF SLOPE]: Adjusts the crossover slope.  
Selectable only if a setting other than [THROUGH] is selected for the crossover frequency.
- [SW LPF PHASE]/[PHASE]: Selects the phase of the speaker output to be in line with the other speaker output.
- [GAIN LEFT]/[GAIN RIGHT]/[F-HPF GAIN]/[R-HPF GAIN]/[SW LPF GAIN]/[GAIN]: Adjusts the output volume of the selected speaker.

### 2-way crossover setting items

#### SPEAKER SIZE

|               |         |   |
|---------------|---------|---|
| FRONT         | SIZE    | 3.5"/4"/4.75"/5"/ <u>6.5</u> "/6.75"/7"/4×6/5×7/6×8/<br>6×9/7×10                      |
|               | TWEETER | SMALL/ <u>MIDDLE</u> /LARGE/NONE (not connected)                                      |
| REAR*1        |         | 3.5"/4"/4.75"/5"/ <u>6.5</u> "/6.75"/7"/4×6/5×7/6×8/6×9/7×10/<br>NONE (not connected) |
| SUBWOOFER*2*3 |         | 6.5"/8"/ <u>10</u> "/12"/15" OVER/NONE (not connected)                                |

#### X' OVER

|                      |              |  |
|----------------------|--------------|--|
| TWEETER              | FRQ          | 1KHZ/1.6KHZ/2.5KHZ/ <u>4KHZ</u> /5KHZ/6.3KHZ/8KHZ/<br>10KHZ/12.5KHZ                        |
|                      | GAIN LEFT    | -08DB to <u>00DB</u>   |
|                      | GAIN RIGHT   | -08DB to <u>00DB</u>   |
| FRONT HPF            | F-HPF FRQ    | 30HZ/40HZ/50HZ/60HZ/70HZ/80HZ/90HZ/100HZ/<br>120HZ/150HZ/180HZ/220HZ/250HZ/ <u>THROUGH</u> |
|                      | F-HPF SLOPE  | -06DB/ <u>-12DB</u> /-18DB/-24DB   |
|                      | F-HPF GAIN   | -08DB to <u>00DB</u>   |
| REAR HPF*1           | R-HPF FRQ    | 30HZ/40HZ/50HZ/60HZ/70HZ/80HZ/90HZ/100HZ/<br>120HZ/150HZ/180HZ/220HZ/250HZ/ <u>THROUGH</u> |
|                      | R-HPF SLOPE  | -06DB/ <u>-12DB</u> /-18DB/-24DB   |
|                      | R-HPF GAIN   | -08DB to <u>00DB</u>   |
| SUBWOOFER<br>LPF*2*3 | SW LPF FRQ   | 30HZ/40HZ/50HZ/60HZ/70HZ/80HZ/90HZ/100HZ/<br>120HZ/150HZ/180HZ/220HZ/250HZ/ <u>THROUGH</u> |
|                      | SW LPF SLOPE | -06DB/ <u>-12DB</u> /-18DB/-24DB   |
|                      | SW LPF PHASE | REVERSE (180°)/ <u>NORMAL</u> (0°)   |
|                      | SW LPF GAIN  | -08DB to <u>00DB</u>   |

\*1, \*2, \*3: (➔ 27)

## AUDIO SETTINGS

### 3-way crossover setting items

| SPEAKER SIZE |  |
|--------------|--|
| TWEETER      | SMALL/MIDDLE/LARGE   |
| MID RANGE    | 3.5"/4"/4.75"/5"/6.5"/6.75"/7"/4×6/5×7/6×8/6×9   |
| WOOFER*3     | 6.5"/8"/10"/12"/15" OVER/NONE (not connected)  |
| X ' OVER     |  |
| TWEETER      | HPF FRQ 1KHZ/1.6KHZ/2.5KHZ/4KHZ/5KHZ/6.3KHZ/8KHZ/10KHZ/12.5KHZ                         |
|              | SLOPE -06DB/-12DB  |
|              | PHASE REVERSE (180°)/NORMAL (0°)   |
|              | GAIN -08DB to 00DB   |
| MID RANGE    | HPF FRQ 30HZ/40HZ/50HZ/60HZ/70HZ/80HZ/90HZ/100HZ/120HZ/150HZ/180HZ/220HZ/250HZ/THROUGH |
|              | HPF SLOPE -06DB/-12DB  |
|              | LPF FRQ 1KHZ/1.6KHZ/2.5KHZ/4KHZ/5KHZ/6.3KHZ/8KHZ/10KHZ/12.5KHZ/THROUGH                 |
|              | LPF SLOPE -06DB/-12DB  |
|              | PHASE REVERSE (180°)/NORMAL (0°)   |
|              | GAIN -08DB to 00DB   |
| WOOFER*3     | LPF FRQ 30HZ/40HZ/50HZ/60HZ/70HZ/80HZ/90HZ/100HZ/120HZ/150HZ/180HZ/220HZ/250HZ/THROUGH |
|              | SLOPE -06DB/-12DB  |
|              | PHASE REVERSE (180°)/NORMAL (0°)   |
|              | GAIN -08DB to 00DB   |

\*1 Displayed only when [SPK/PRE OUT] is set to [REAR/REAR] or [REAR/SUB.W]. (⇒ 25)

\*2 KD-X255BT: Displayed only when [SPK/PRE OUT] is set to [REAR/SUB.W] or [SUB.W/SUB.W]. (⇒ 25)

\*3 Displayed only when [SUBWOOFER SET] is set to [ON]. (⇒ 24)

### Digital Time Alignment settings

Digital Time Alignment sets the delay time of the speaker output to create a more suitable environment for your vehicle.

- For more information, ⇒ 28, Determining the value for [DISTANCE] and [GAIN] of [DTA SETTINGS].

#### DTA SETTINGS

|            |   |
|------------|---|
| POSITION   | Selects your listening position (reference point).<br><b>ALL</b> : Not compensating ; <b>FRONT RIGHT</b> : Front right seat ; <b>FRONT LEFT</b> : Front left seat ; <b>FRONT ALL</b> : Front seat<br>• [FRONT ALL] is displayed only when [X ' OVER TYPE] is set to [2-WAY]. (⇒ 24) |
| DISTANCE*1 | 0FT to 20.01FT: Fine adjust the distance to compensate.   |
| GAIN*1     | -8DB to 0DB: Fine adjust the output volume of the selected speaker.   |
| DTA RESET  | <b>YES</b> : Resets the settings ([DISTANCE] and [GAIN]) of the selected [POSITION] to default. ; <b>NO</b> : Cancels.  |

#### CAR SETTINGS

|                 |  |
|-----------------|--|
| CAR TYPE        | <b>COMPACT/FULL SIZE CAR/WAGON/MINIVAN/SUV/MINIVAN(LONG)</b> : Selects the type of vehicle. ; <b>OFF</b> : Not compensating.   |
| R-SP LOCATION*2 | Selects the location of the rear speakers in your vehicle to calculate the furthest distance from the listening position selected (reference point).<br>• <b>DOOR/REAR DECK</b> : Selectable only when [CAR TYPE] is selected as [OFF], [COMPACT], [FULL SIZE CAR], [WAGON] or [SUV].<br>• <b>2ND ROW/3RD ROW</b> : Selectable only when [CAR TYPE] is selected as [MINIVAN] or [MINIVAN(LONG)]. |

\*1, \*2: (⇒ 28)



## AUDIO SETTINGS

### Determining the value for [DISTANCE] and [GAIN] of [DTA SETTINGS]

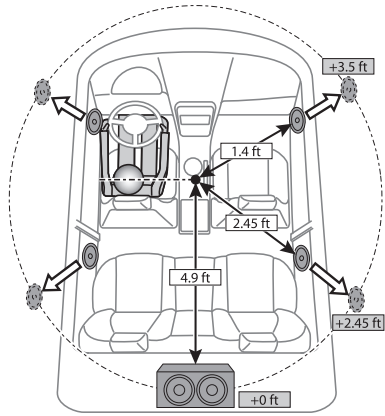

If you specify the distance from the center of the currently set listening position to every speaker, the delay time will be automatically computed and set.

- 1 Determine the center of the currently set listening position as the reference point.
- 2 Measure the distances from the reference point to the speakers.
- 3 Calculate the differences between the distance of the furthest speaker (rear speaker) and other speakers.
- 4 Set the [DISTANCE] calculated in step 3 for individual speakers.
- 5 Adjust [GAIN] for individual speakers.

Example: When [FRONT ALL] is selected as the listening position

\*1 Before making an adjustment, select the speaker:

When 2-way crossover is selected:

**FRONT LEFT/FRONT RIGHT/REAR LEFT/REAR RIGHT/SUBWOOFER:**  
[REAR LEFT], [REAR RIGHT] and [SUBWOOFER] is selectable only if a setting other than [NONE] is selected for [REAR] and [SUBWOOFER] of [SPEAKER SIZE]. (→ 26)

When 3-way crossover is selected:

**TWEETER LEFT/TWEETER RIGHT/MID LEFT/MID RIGHT/WOOFER:**  
[WOOFER] is selectable only if a setting other than [NONE] is selected for [WOOFER] of [SPEAKER SIZE]. (→ 27)

\*2 Displayed only when [X' OVER TYPE] is set to [2-WAY] (→ 24) and if a setting other than [NONE] is selected for [REAR] of [SPEAKER SIZE]. (→ 26)

## DISPLAY SETTINGS

Zone identification for brightness setting

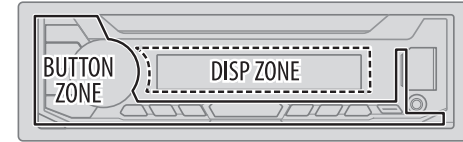

Zone identification for color setting (for KD-X350BTS/KD-X35MBS)

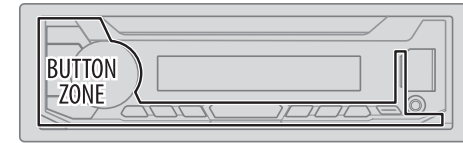

- 1 Press and hold · .
- 2 Turn the volume knob to select an item (see the following table), then press the knob.
- 3 Repeat step 2 until the desired item is selected/activated or follow the instructions stated on the selected item.
- 4 Press · to exit.

To return to the previous setting item, press / .

Default: XX

### DISPLAY

|               |   |
|---------------|---|
| <b>DIMMER</b> | Dim the illumination.<br><b>OFF:</b> Dimmer is turned off. Brightness changes to [DAY] setting.<br><b>ON:</b> Dimmer is turned on. Brightness changes to [NIGHT] setting. (→ 29, [BRIGHTNESS])<br><b>DIMMER TIME:</b> Set the dimmer on and off time.<br><b>1</b> Turn the volume knob to adjust the [ON] time, then press the knob.<br><b>2</b> Turn the volume knob to adjust the [OFF] time, then press the knob.<br>(Default: [ON]: <u>PM6:00</u> ; [OFF]: <u>AM6:00</u> )<br><b>DIMMER AUTO:</b> Dimmer turns on and off automatically when you turn off or on the car headlights.*1 |
|---------------|---|

\*1 The illumination control wire connection is required. (→ 39)



## DISPLAY SETTINGS

|   |  |
|---|--|
| <b>BRIGHTNESS</b>                       | Set the brightness for day and night separately.<br><b>1 DAY/NIGHT:</b> Select day or night.<br><b>2</b> Select a zone. (➔ 28)<br><b>3 LEVEL 00 to LEVEL 31:</b> Set the brightness level.   |
| <b>TEXT SCROLL</b> *2                   | <b>SCROLL ONCE:</b> Scrolls the display information once. ;<br><b>SCROLL AUTO:</b> Repeats scrolling at 5-second intervals. ;<br><b>SCROLL OFF:</b> Cancels.   |
| <b>COLOR (for KD-X350BTS/KD-X35MBS)</b> |  |
| <b>PRESET</b>                           | Select an illumination color for the buttons. <ul style="list-style-type: none"><li>• <b>COLOR 01 to COLOR 49</b></li><li>• <b>USER:</b> The color you have created for [DAY COLOR] or [NIGHT COLOR] is shown.</li><li>• <b>COLOR FLOW01 to COLOR FLOW03:</b> Color changes at different speeds.</li></ul> |
| <b>DAY COLOR</b>                        | Store your own day and night illumination colors for the buttons.<br><b>1 RED/GREEN/BLUE:</b> Select a primary color.<br><b>2 00 to 31:</b> Select the level.  |
| <b>NIGHT COLOR</b>                      | Repeat steps <b>1</b> and <b>2</b> for all the primary colors. <ul style="list-style-type: none"><li>• Your setting is stored to [USER] in [PRESET].</li><li>• [NIGHT COLOR] or [DAY COLOR] is changed by turning on or off your car's headlight.</li></ul>  |
| <b>MENU COLOR</b>                       | <b>ON:</b> The color of buttons illumination changes to white color when in menu mode or when selecting a music file from a folder/list. ; <b>OFF:</b> Cancels.  |

\*2 Some characters or symbols will not be shown correctly (or will be blanked).

## REFERENCES

### ■ Maintenance

#### Cleaning the unit

Wipe off dirt on the faceplate with a dry silicone or soft cloth.

#### Cleaning the connector

Detach the faceplate and clean the connector gently with a cotton swab, being careful not to damage the connector.

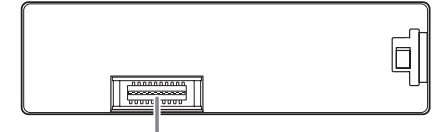

Connector (on the reverse side of the faceplate)

### ■ More information

For: – Latest firmware updates and latest compatible item list

– JVC original application

– Any other latest information

Visit <<http://www.jvc.net/cs/car/>>.

#### Playable files

• For detailed information and notes about the playable audio files, visit <<http://www.jvc.net/cs/car/>>.

• Playable audio file:

MP3 (.mp3), WMA (.wma), AAC (.aac), AAC (.m4a), WAV (.wav), FLAC (.flac)

• Playable USB device file system: FAT12, FAT16, FAT32

Even when audio files comply with the standards listed above, playback may be impossible depending on the types or conditions of media or device.

#### About USB devices

• You cannot connect a USB device via a USB hub.

• Connecting a cable whose total length is longer than 5 m may result in abnormal playback.

• This unit cannot recognize a USB device whose rating is other than 5 V and exceeds 1.5 A.

## REFERENCES

---

### About iPod/iPhone

- Via USB input terminal:  
Made for
  - iPod touch (5th and 6th generation)
  - iPod nano (7th generation)
  - iPhone 4S, 5, 5S, 5C, 6, 6 Plus, 6S, 6S Plus, SE, 7, 7 Plus
- Via Bluetooth:  
Made for
  - iPod touch (5th and 6th generation)
  - iPhone 4S, 5, 5S, 5C, 6, 6 Plus, 6S, 6S Plus, SE, 7, 7 Plus
- It is not possible to browse video files on the “Videos” menu in **[HEAD MODE]**.
- The song order displayed on the selection menu of this unit may differ from that of the iPod/iPhone.
- Depending on the version of the operating system of the iPod/iPhone, some functions may not operate on this unit.

### About Android device

- This unit supports Android OS 4.1 and above.
- Some Android devices (with OS 4.1 and above) may not fully support Android Open Accessory (AOA) 2.0.
- If the Android device supports both mass storage class device and AOA 2.0, this unit always playback via AOA 2.0 as priority.

### About Pandora

- Pandora is only available in certain countries.  
For more information, visit <<http://www.pandora.com/legal>>.
- Because Pandora is a third-party service, the specifications are subject to change without prior notice. Accordingly, compatibility may be impaired, or some or all of the services may become unavailable.
- Some functions of Pandora cannot be operated from this unit.
- For issues using the application, please contact Pandora at [pandora-support@pandora.com](mailto:pandora-support@pandora.com).

### About iHeartRadio

- iHeartRadio® is a third-party service, therefore the specifications are subject to change without prior notice. Accordingly, compatibility may be impaired or some or all of the services may become unavailable.
- Some iHeartRadio® functionality cannot be operated from this unit.

### About Spotify

- Spotify application supports:
  - iPhone 4S, 5, 5S, 5C, 6, 6 Plus, 6S, 6S Plus, SE, 7, 7 Plus (iOS 8 or above)
  - iPod touch (5th and 6th generation)
  - Android OS 4.0.3 or above
- Spotify is a third party service, therefore the specifications are subject to change without prior notice. Accordingly, compatibility may be impaired or some or all of the services may become unavailable.
- Some functions of Spotify cannot be operated from this unit.
- For issues using the application, please contact Spotify at <[www.spotify.com](http://www.spotify.com)>.

### About Bluetooth

- Depending on the Bluetooth version of the device, some Bluetooth devices may not be able to connect to this unit.
- This unit may not work with some Bluetooth devices.
- Signal conditions vary, depending on the surroundings.

## REFERENCES

### Change the display information

Each time you press  , the display information changes.

- If the information is unavailable or not recorded, "NO TEXT", "NO NAME", or other information (eg. station name) appears or display will be blank.

| Source name                 | Display information  |   |
|-----------------------------|--|---|
|                             | KD-X350BTS/KD-X35MBS   | KD-X255BT   |
| FM or AM                    | Frequency (Date/Clock)*1 → Frequency (Date) with music synchronisation*2 → (back to the beginning)   | Frequency → Clock → Frequency with music synchronisation*2 → (back to the beginning)  |
|                             | <b>(For FM Radio Broadcast Data System stations only)</b><br>Station name (PS)/Program type (PTY) (Date/Clock)*1 → Radio text (Date/Clock)*1 → Radio text+ (Radio text+) → Song title (Artist) → Song title (Date/Clock)*1 → Frequency (Date/Clock)*1 → Station name (PS)/Program type (PTY) (Date) with music synchronisation*2 → (back to the beginning) | <b>(For FM Radio Broadcast Data System stations only)</b><br>Station name (PS)/Program type (PTY) → Radio text → Radio text+ → Radio text+ title/Radio text+ artist → Frequency → Clock → Station name (PS)/Program type (PTY) with music synchronisation*2 → (back to the beginning) |
| USB                         | <b>(For MP3/WMA/AAC/WAV/FLAC files)</b><br>Song title (Artist) → Song title (Album name) → Song title (Date/Clock)*1 → File name (Folder name) → File name (Date/Clock)*1 → Playing time (Date/Clock)*1 → Song title (Artist) with music synchronisation*2 → (back to the beginning)   | <b>(For MP3/WMA/AAC/WAV/FLAC files)</b><br>Song title/Artist → Album name/Artist → Folder name → File name → Playing time → Clock → Song title/Artist with music synchronisation*2 → (back to the beginning)  |
| iPod USB/iPod BT or ANDROID | When [HEAD MODE]/[AUTO MODE] is selected (→ 8):<br>Song title (Artist) → Song title (Album name) → Song title (Date/Clock)*1 → Playing time (Date/Clock)*1 → Song title (Artist) with music synchronisation*2 → (back to the beginning)  | When [HEAD MODE]/[AUTO MODE] is selected (→ 8):<br>Song title/Artist → Album name/Artist → Playing time → Clock → Song title/Artist with music synchronisation*2 → (back to the beginning)  |
| PANDORA/<br>PANDORA BT      | Station name (Date/Clock)*1 → Shared/Radio (Date/Clock)*1 → Song title (Artist) → Song title (Album name) → Song title (Date/Clock)*1 → Playing time (Date/Clock)*1 → Station name (Date) with music synchronisation*2 → (back to the beginning)   | Station name → Shared/Radio → Song title → Artist name → Album name → Playing time → Clock → Station name with music synchronisation*2 → (back to the beginning)  |
| IHEARTRADIO                 | Station name (Date/Clock)*1 → Song title (Artist) → Song title (Date/Clock)*1 → Station name (Date) with music synchronisation*2 → (back to the beginning)   | Station name → Song title/Artist → Clock → Station name with music synchronisation*2 → (back to the beginning)  |

\*1, \*2: (→ 32)

## REFERENCES

| Source name        | Display information  |   |
|--------------------|--|---|
|                    | KD-X350BTS/KD-X35MBS   | KD-X255BT   |
| SPOTIFY/SPOTIFY BT | Context title (Date/Clock)*1 → Song title (Artist) → Song title (Album name) → Song title (Date/Clock)*1 → Playing Time (Date/Clock)*1 → Context title (Date) with music synchronisation*2 → (back to the beginning)                             | Context title → Song title → Artist name → Album name → Playing Time → Clock → Context title with music synchronisation*2 → (back to the beginning) |
| SIRIUS XM          | Channel number (Status) → Channel name (Status) → Artist (Status) → Song title (Status) → Content information (Status) → Category name (Status) → Date (Status) → Channel number (Status) with music synchronisation*2 → (back to the beginning) | —   |
| BT AUDIO           | Song title (Artist) → Song title (Album name) → Song title (Date/Clock)*1 → Playing time (Date/Clock)*1 → Song title (Artist) with music synchronisation*2 → (back to the beginning)   | Song title/Artist → Album name/Artist → Playing time → Clock → Song title/Artist with music synchronisation*2 → (back to the beginning)             |
| AUX                | AUX (Date/Clock)*1 → AUX (Date) with music synchronisation*2 → (back to the beginning)   | AUX → Clock → AUX with music synchronisation*2 → (back to the beginning)  |

\*1 Battery and signal strength of the Bluetooth device will be shown if [BATT/SIGNAL] is set to [AUTO]. (→ 17)

\*2 For **KD-X350BTS/KD-X35MBS**: The color of the button illumination changes and synchronises with the music.

For **KD-X255BT**: The brightness of the button illumination changes and synchronises with the music.

# TROUBLESHOOTING

|          | Symptom  | Remedy   |
|----------|--|--|
| General  | Sound cannot be heard.   | <ul style="list-style-type: none"> <li>Adjust the volume to the optimum level.</li> <li>Check the cords and connections.</li> </ul>  |
|          | "MISWIRING CHECK WIRING THEN PWR ON" appears.  | Turn the power off, then check to be sure the terminals of the speaker wires are insulated properly. Turn the power on again.  |
|          | "PROTECTING SEND SERVICE" appears.   | Send the unit to the nearest service center.   |
|          | Source cannot be selected.   | Check the [SOURCE SELECT] setting. (➔ 4)   |
| Radio    | <ul style="list-style-type: none"> <li>Radio reception is poor.</li> <li>Static noise while listening to the radio.</li> </ul> | Connect the antenna firmly.  |
| USB/iPod | Playback order is not as intended.   | The playback order is determined by the file name.   |
|          | Elapsed playing time is not correct.   | This depends on the recording process earlier.   |
|          | "NOT SUPPORT" appears and file skips.  | Check whether the file is a playable format. (➔ 29)  |
|          | "READING" keeps flashing.  | <ul style="list-style-type: none"> <li>Do not use too many hierarchical levels and folders.</li> <li>Reattach the USB device.</li> </ul>   |
|          | "UNSUPPORTED DEVICE" appears.  | <ul style="list-style-type: none"> <li>Check whether the connected device is compatible with this unit and ensure the file systems are in supported formats. (➔ 29)</li> <li>Reattach the device.</li> </ul> |
|          | "UNRESPONSIVE DEVICE" appears.   | Make sure the device is not malfunction and reattach the device.   |

|          | Symptom   | Remedy  |
|----------|---|---|
| USB/iPod | "USB HUB IS NOT SUPPORTED" appears.   | This unit cannot support a USB device connected via a USB hub.  |
|          | "CANNOT PLAY" appears.  | Connect a USB device that contains playable audio files.  |
|          | <ul style="list-style-type: none"> <li>The source does not change to "USB" when you connect a USB device while listening to another source.</li> <li>"USB ERROR" appears</li> </ul> | The USB port is drawing more power than the design limit. Turn the power off and unplug the USB device. Then, turn on the power and reattach the USB device. If this does not solve the problem, turn the power off and on (or reset the unit) before replacing with another USB device.  |
|          | The iPod/iPhone does not turn on or does not work   | <ul style="list-style-type: none"> <li>Check the connection between this unit and iPod/iPhone.</li> <li>Disconnect and reset the iPod/iPhone using hard reset.</li> </ul>   |
|          | "LOADING" appears when you enter search mode by pressing <b>Q</b> / <b>↵</b> .  | This unit is still preparing the iPod/iPhone music list. It may take some time to load, try again later.  |
|          | Correct characters are not displayed.   | <ul style="list-style-type: none"> <li>This unit can only display uppercase letters, numbers, and a limited number of symbols.</li> <li>Depending on the display language you have selected (➔ 5), some characters may not be displayed correctly.</li> </ul>   |
| ANDROID  | <ul style="list-style-type: none"> <li>Sound cannot be heard during playback.</li> <li>Sound output only from the Android device.</li> </ul>  | <ul style="list-style-type: none"> <li>Reconnect the Android device.</li> <li>If in [AUDIO MODE], launch any media player application on the Android device and start playback.</li> <li>If in [AUDIO MODE], relaunch the current media player application or use another media player application.</li> <li>Restart the Android device.</li> <li>If this does not solve the problem, the connected Android device is unable to route the audio signal to unit. (➔ 30)</li> </ul> |

## TROUBLESHOOTING

|         | Symptom                                  | Remedy   |
|---------|--|--|
| ANDROID | Cannot playback at [AUTO MODE].          | <ul style="list-style-type: none"> <li>• Make sure JVC MUSIC PLAY APP is installed on the Android device. (➔ 7)</li> <li>• Reconnect the Android device and select the appropriate control mode. (➔ 8)</li> <li>• If this does not solve the problem, the connected Android device does not support [AUTO MODE]. (➔ 30)</li> </ul> |
|         | "NO DEVICE" or "READING" keeps flashing. | <ul style="list-style-type: none"> <li>• Switch off the developer options on the Android device.</li> <li>• Reconnect the Android device.</li> <li>• If this does not solve the problem, the connected Android device does not support [AUTO MODE]. (➔ 30)</li> </ul>  |
|         | Playback is intermittent or sound skips. | Turn off the power saving mode on the Android device.  |
|         | "CANNOT PLAY"                            | <ul style="list-style-type: none"> <li>• Make sure Android device contains playable audio files.</li> <li>• Reconnect the Android device.</li> <li>• Restart the Android device.</li> </ul>  |
| Pandora | "ADD ERROR"                              | New station creation is unsuccessful.  |
|         | "CHK DEVICE"                             | Check the Pandora application on your device.  |
|         | "NO SKIPS"                               | The skip limit has been reached.   |
|         | "NO STATIONS"                            | No stations are found.   |
|         | "STATION LMT"                            | The number of registered stations has reached its limit. Retry after deleting unnecessary stations from your device.   |
|         | "UPGRADE APP"                            | Make sure you have installed the latest version of the Pandora application on your device.   |
|         | "CONNECT ERR"                            | Communication is unstable.   |

|                 | Symptom                     | Remedy  |
|-----------------|-----------------------------|---|
| Pandora         | "RATING ERR"                | Registration of thumbs up/thumbs down has failed due to insufficient network connectivity.  |
|                 | "THUMBS N/A"                | Registration of thumbs up/thumbs down is not allowed.   |
|                 | "LICENSE ERR"               | You try to access from a country which Pandora is not deliverable.  |
| iHeartRadio     | Station cannot be selected. | If "Explicit Content" in [Account Settings] is checked in the web version of iHeartRADIO, custom stations become unavailable.   |
|                 | "NOT CONNECTD"              | Link to the application is impossible.  |
| Spotify         | "DISCONNECTED"              | USB is disconnected from the head unit. Please make sure the device is connected properly through USB.  |
|                 | "CONNECTING"                | <ul style="list-style-type: none"> <li>• Connected via USB input terminal: The device is connecting to the head unit. Please wait.</li> <li>• Connected via Bluetooth: The Bluetooth is disconnected. Please check Bluetooth connection and make sure both the device and unit are paired and connected.</li> </ul> |
|                 | "CHECK APP"                 | The Spotify application is not connected properly, or user is not login. End the Spotify application and restart, then log in to your Spotify account.  |
|                 | "CH LOCKED LOCK CODE?"      | The selected channel is locked. Enter the correct pass code to unlock. (➔ 14)   |
| SiriusXM® Radio | "CHAN UNSUB"                | The selected channel is unsubscribed. Call 1-866-635-2349 in the U.S.A. or 1-877-438-9677 in Canada to subscribe.   |
|                 | "CH UNAVAIL"                | The selected channel is unavailable. For more information about the SiriusXM channel lineup, visit <www.siriusxm.com>.  |

## TROUBLESHOOTING

|                 | Symptom   | Remedy  |
|-----------------|---|---|
| SiriusXM® Radio | "CHECK ANTENNA"                                   | Check that the antenna and its connection are in good condition.  |
|                 | "CHECK TUNER"                                     | Make sure the SiriusXM Vehicle Tuner is connected to the unit.  |
|                 | "NO SIGNAL"                                       | Make sure the antenna is mounted outside the vehicle.   |
|                 | "SUBSCRIPTION UPDATED – PRESS ENTER TO CONTINUE." | Your subscription is updated. Press the volume knob to continue.  |
|                 | "CODE ERROR"                                      | Make sure you have entered the correct pass code. (➔ 14)  |
|                 | "NO CONTENT"                                      | There is insufficient content to start TuneScan.  |
|                 | "SCAN CANCEL"                                     | TuneScan has been aborted.  |
| Bluetooth®      | No Bluetooth device is detected.                  | <ul style="list-style-type: none"> <li>• Search from the Bluetooth device again.</li> <li>• Reset the unit. (➔ 3)</li> </ul>  |
|                 | Pairing cannot be made.                           | <ul style="list-style-type: none"> <li>• Make sure you have entered the same PIN code to both the unit and Bluetooth device.</li> <li>• Delete pairing information from both the unit and the Bluetooth device, then perform pairing again. (➔ 15)</li> </ul> |
|                 | Echo or noise occurs.                             | <ul style="list-style-type: none"> <li>• Adjust the microphone unit's position. (➔ 15)</li> <li>• Check the [ECHO CANCEL] setting. (➔ 17)</li> </ul>  |
|                 | Phone sound quality is poor                       | <ul style="list-style-type: none"> <li>• Reduce the distance between the unit and the Bluetooth device.</li> <li>• Move the car to a place where you can get a better signal reception.</li> </ul>  |

|            | Symptom  | Remedy  |
|------------|--|---|
| Bluetooth® | Sound is being interrupted or skipped during playback of a Bluetooth audio player. | <ul style="list-style-type: none"> <li>• Reduce the distance between the unit and the Bluetooth audio player.</li> <li>• Turn off, then turn on the unit and try to connect again.</li> <li>• Other Bluetooth devices might be trying to connect to the unit.</li> </ul>    |
|            | The connected Bluetooth audio player cannot be controlled.                         | <ul style="list-style-type: none"> <li>• Check whether the connected Bluetooth audio player supports Audio/Video Remote Control Profile (AVRCP). (Refer to the instructions of your audio player.)</li> <li>• Disconnect and connect the Bluetooth player again.</li> </ul> |
|            | "PLEASE WAIT"  | The unit is preparing to use the Bluetooth function. If the message does not disappear, turn off and turn on the unit, then connect the device again.   |
|            | "NOT SUPPORT"  | The connected phone does not support Voice Recognition feature.   |
|            | "ERROR"  | Try the operation again. If "ERROR" appears again, check if the device supports the function you have tried.  |
|            | "H/W ERROR"  | Reset the unit and try the operation again. If "H/W ERROR" appears again, consult your nearest service center.  |
|            | "SWITCHING NG"   | The connected phones might not support phone switching feature.   |

### If you have any troubles, try the following:

- 1 Check TROUBLESHOOTING
- 2 Reset the unit (➔ 3)
- 3 Contact (USA only)  
Call: 1-800-252-5722 ( or ) visit: <<http://www.jvc.com>>

# SPECIFICATIONS

|                                  |  |   |
|----------------------------------|--|---|
| Tuner                            | FM Frequency Range                     | 87.9 MHz — 107.9 MHz (200 kHz step)<br>87.5 MHz — 108.0 MHz (50 kHz step) |
|                                  | Usable Sensitivity (S/N = 26 dB)       | 8.2 dBf (0.71 $\mu$ V/75 $\Omega$ )                                       |
|                                  | Quieting Sensitivity (DIN S/N = 46 dB) | 17.2 dBf (2.0 $\mu$ V/75 $\Omega$ )                                       |
|                                  | Frequency Response ( $\pm 3$ dB)       | 30 Hz — 15 kHz  |
|                                  | Signal-to-Noise Ratio (MONO)           | 64 dB   |
|                                  | Stereo Separation (1 kHz)              | 40 dB   |
|                                  | AM Frequency Range                     | 530 kHz — 1 700 kHz (10 kHz step)<br>531 kHz — 1 611 kHz (9 kHz step)     |
| Usable Sensitivity (S/N = 20 dB) | 29 dB $\mu$ (28.2 $\mu$ V)             |   |

|             |                                  |  |
|-------------|----------------------------------|--|
| USB         | USB Standard                     | USB 1.1, USB 2.0 (Full speed)                |
|             | Compatible Devices               | Mass storage class                           |
|             | File System                      | FAT12/16/32                                  |
|             | Maximum Supply Current           | DC 5 V $\leq$ 1.5 A                          |
|             | D/A Converter                    | 24 Bit                                       |
|             | Frequency Response ( $\pm 1$ dB) | 20 Hz — 20 kHz                               |
|             | Signal-to-Noise Ratio (1 kHz)    | 105 dB                                       |
|             | Dynamic Range                    | 90 dB  |
|             | Channel Separation               | 85 dB  |
|             | MP3 Decode                       | Compliant with MPEG-1/2 Audio Layer-3        |
|             | WMA Decode                       | Compliant with Windows Media Audio           |
|             | AAC Decode                       | AAC-LC “.aac”, “.m4a” files                  |
|             | WAV Decode                       | RIFF waveform Audio Format (Linear PCM only) |
| FLAC Decode | FLAC file, up to 24 bit/96 kHz   |  |

|           |                                  |                |
|-----------|----------------------------------|----------------|
| Auxiliary | Frequency Response ( $\pm 3$ dB) | 20 Hz — 20 kHz |
|           | Input Maximum Voltage            | 1 000 mV       |
|           | Input Impedance                  | 30 k $\Omega$  |

|           |                             |  |
|-----------|-----------------------------|--|
| Bluetooth | Version                     | Bluetooth 3.0  |
|           | Frequency Range             | 2.402 GHz — 2.480 GHz  |
|           | Output Power                | +4 dBm (MAX), 0 dBm (AVE) Power Class 2  |
|           | Maximum Communication Range | Line of sight approx. 10 m (32.8 ft)   |
|           | Pairing                     | SSP (Secure Simple Pairing)  |
|           | Profile                     | HFP1.6 (Hands-Free Profile)<br>A2DP (Advanced Audio Distribution Profile)<br>AVRCP1.5 (Audio/Video Remote Control Profile)<br>PBAP (Phonebook Access Profile)<br>SPP (Serial Port Profile) |

|       |   |   |
|-------|---|---|
| Audio | Maximum Output Power                        | 50 W $\times$ 4 or<br>50 W $\times$ 2 + 50 W $\times$ 1 (Subwoofer = 4 $\Omega$ )                               |
|       | Full Bandwidth Power (at less than 1 % THD) | 22 W $\times$ 4   |
|       | Speaker Impedance                           | 4 $\Omega$ — 8 $\Omega$   |
|       | Preout Level/Load (USB)                     | <b>KD-X350BTS/KD-X35MBS:</b><br>4 000 mV/10 k $\Omega$ load<br><b>KD-X255BT:</b><br>2 500 mV/10 k $\Omega$ load |
|       | Preout Impedance                            | $\leq$ 600 $\Omega$   |



## SPECIFICATIONS

|         |   |  |
|---------|---|--|
| General | Operating Voltage<br>(10.5 V — 16 V allowable)      | 14.4 V   |
|         | Maximum Current Consumption                         | 10 A   |
|         | Operating Temperature Range                         | -10°C — +60°C  |
|         | Installation Size (W × H × D)                       | 182 mm × 53 mm × 100 mm<br>(7-3/16" × 2-1/8" × 3-15/16") |
|         | Net Weight (includes Trimplate,<br>Mounting Sleeve) | 0.6 kg (1.4 lbs)   |

Subject to change without notice.

## INSTALLATION/CONNECTION

### ⚠ Warning

- The unit can only be used with a 12 V DC power supply, negative ground.
- Disconnect the battery's negative terminal before wiring and mounting.
- Do not connect Battery wire (yellow) and Ignition wire (red) to the car chassis or Ground wire (black) to prevent a short circuit.
- To prevent short circuit:
  - Insulate unconnected wires with vinyl tape.
  - Be sure to ground this unit to the car's chassis again after installation.
  - Secure the wires with cable clamps and wrap vinyl tape around the wires that comes into contact with metal parts to protect the wires.

### ⚠ Caution

- For safety's sake, leave wiring and mounting to professionals. Consult the car audio dealer.
- Install this unit in the console of your vehicle. Do not touch the metal parts of this unit during and shortly after use of the unit. Metal parts such as the heat sink and enclosure become hot.
- Do not connect the ⊖ wires of speakers to the car chassis or Ground wire (black), or connect them in parallel.
- Connect speakers with a maximum power of more than 50 W. If the maximum power of the speakers is lower than 50 W, change the [AMP GAIN] setting to avoid damaging the speakers. (➔ 24)
- Mount the unit at an angle of less than 30°.
- If your vehicle wiring harness does not have the ignition terminal, connect Ignition wire (red) to the terminal on the vehicle's fuse box which provides 12 V DC power supply and is turned on and off by the ignition key.
- Keep all cables away from heat dissipate metal parts.
- After the unit is installed, check whether the brake lamps, blinkers, wipers, etc. on the car are working properly.
- If the fuse blows, first make sure the wires are not touching car's chassis, then replace the old fuse with one that has the same rating.

# INSTALLATION/CONNECTION

## Part list for installation

(A) Faceplate

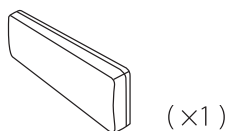

(B) Trim plate

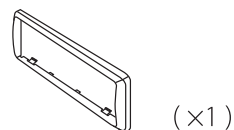

(C) Mounting sleeve

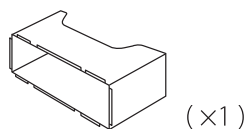

(D) Wiring harness

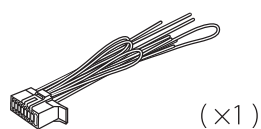

(E) Extraction key

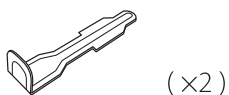

## Basic procedure

- 1 Remove the key from the ignition switch, then disconnect the  $\ominus$  terminal of the car battery.
- 2 Connect the wires properly.  
See Wiring connection. (→ 39)
- 3 Install the unit to your car.  
See Installing the unit (in-dash mounting).
- 4 Connect the  $\ominus$  terminal of the car battery.
- 5 Press **SRC** to turn on the power.
- 6 Detach the faceplate and reset the unit within 5 seconds.  
(→ 3)

## Installing the unit (in-dash mounting)

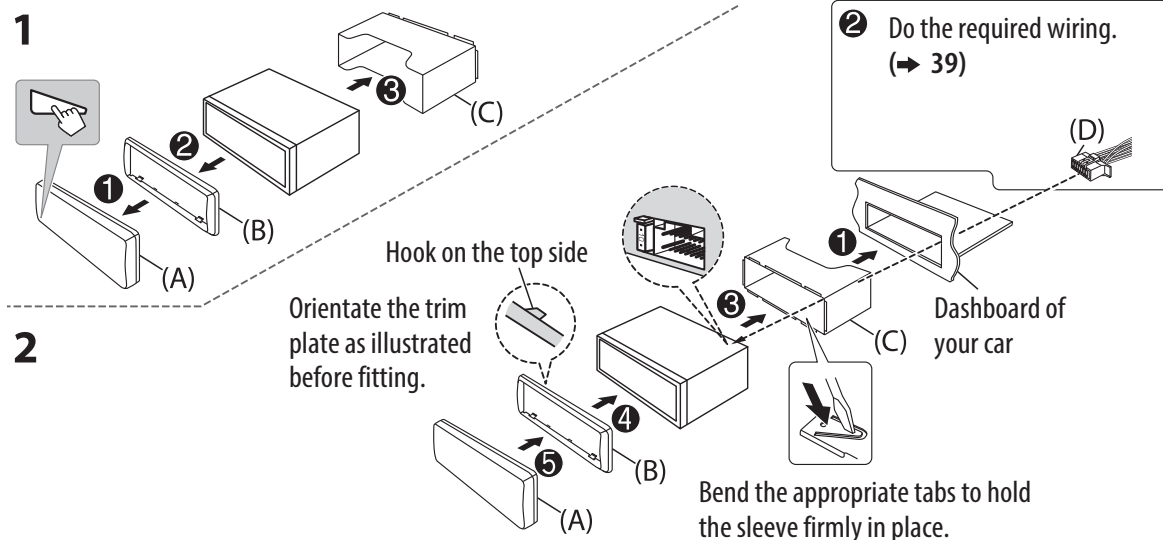

## When installing without the mounting sleeve

- 1 Remove the mounting sleeve and trim plate from the unit.
- 2 Align the holes in the unit (on both sides) with the vehicle mounting bracket and secure the unit with screws (commercially available).

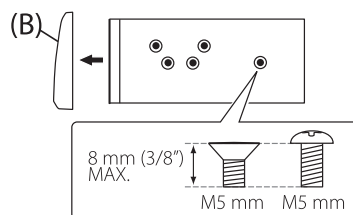

⚠ Use only the specified screws. Using wrong screws might damage the unit.

## How to remove the unit

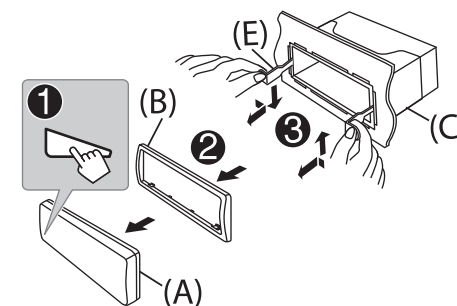

# INSTALLATION/CONNECTION

## Wiring connection

### IMPORTANT

We recommend installing the unit with a commercially available custom wiring harness specific for your car and leave this job to professionals for your safety. Consult your car audio dealer.

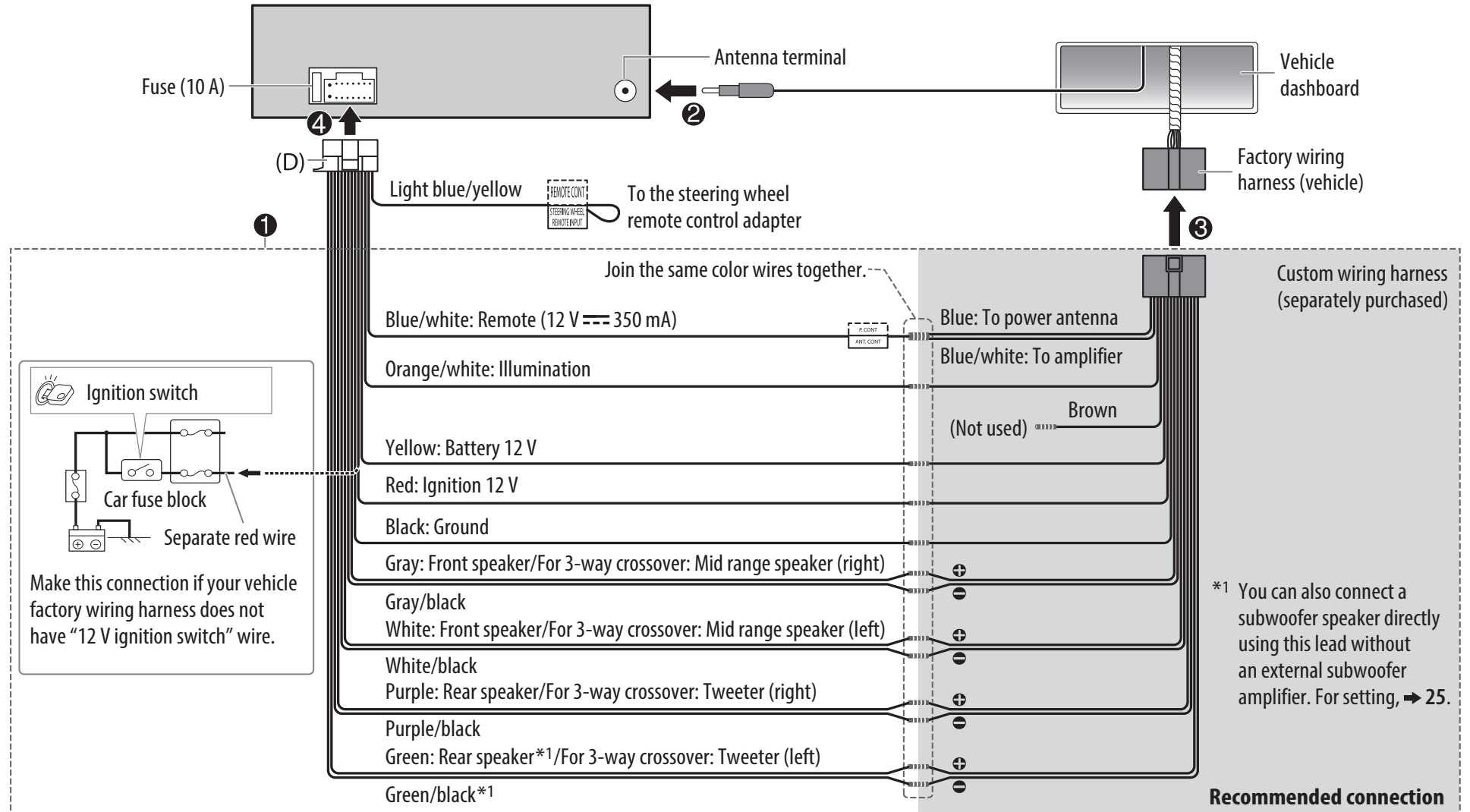

# INSTALLATION/CONNECTION

## Connecting external components

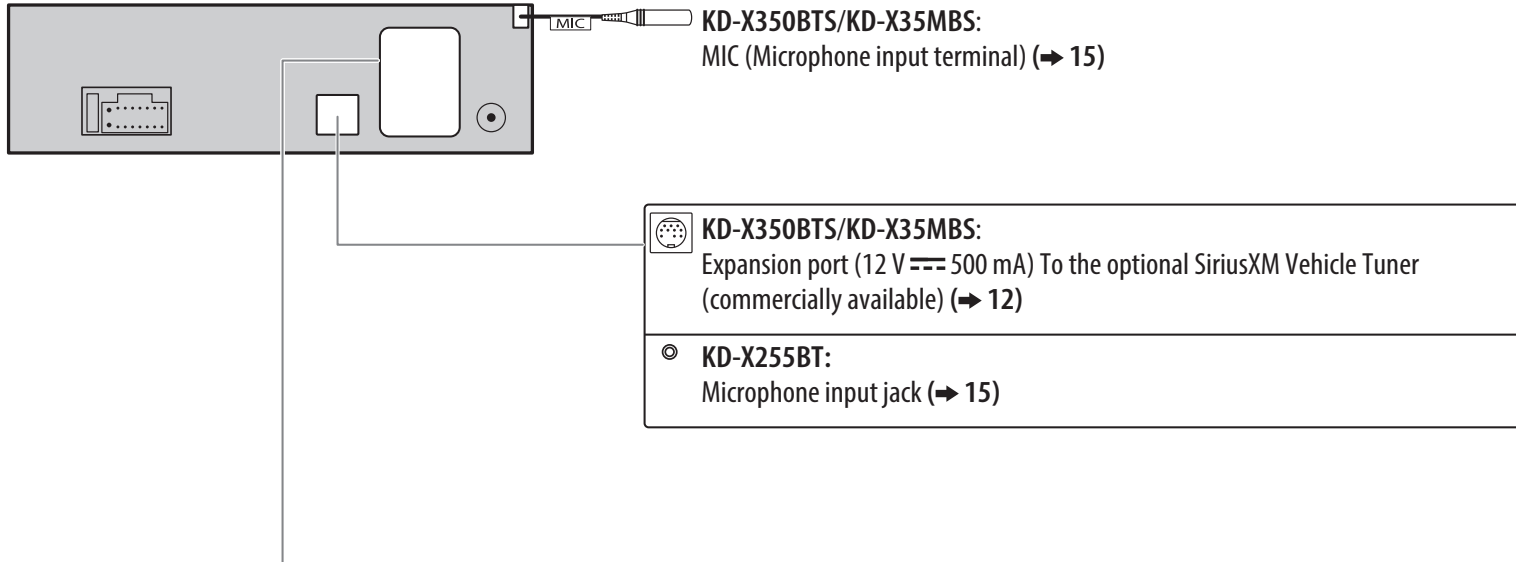

## Connecting external amplifiers via output terminals

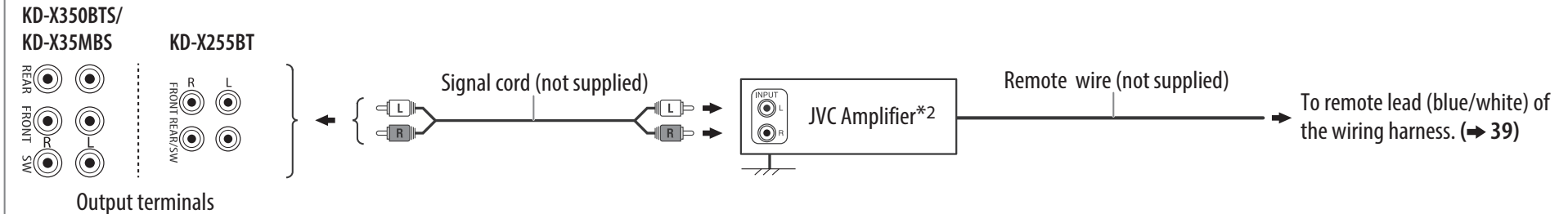

| Output terminals | 2-way crossover setting | 3-way crossover setting |
|------------------|-------------------------|-------------------------|
| REAR             | : Rear output           | Tweeter output          |
| FRONT            | : Front output          | Mid Range output        |
| SW               | : Subwoofer output      | Woofer output           |
| FRONT            | : Front output          | Mid Range output        |
| REAR/SW          | : Rear/subwoofer output | Woofer output           |

\*2 Firmly connect the ground wire of the amplifier to the car's chassis to avoid damaging the unit.

**libFLAC**

Copyright (C) 2000-2009 Josh Coalson

Copyright (C) 2011-2013 Xiph.Org Foundation

Redistribution and use in source and binary forms, with or without modification, are permitted provided that the following conditions are met:

- Redistributions of source code must retain the above copyright notice, this list of conditions and the following disclaimer.
- Redistributions in binary form must reproduce the above copyright notice, this list of conditions and the following disclaimer in the documentation and/or other materials provided with the distribution.
- Neither the name of the Xiph.org Foundation nor the names of its contributors may be used to endorse or promote products derived from this software without specific prior written permission.

THIS SOFTWARE IS PROVIDED BY THE COPYRIGHT HOLDERS AND CONTRIBUTORS "AS IS" AND ANY EXPRESS OR IMPLIED WARRANTIES, INCLUDING, BUT NOT LIMITED TO, THE IMPLIED WARRANTIES OF MERCHANTABILITY AND FITNESS FOR A PARTICULAR PURPOSE ARE DISCLAIMED. IN NO EVENT SHALL THE FOUNDATION OR CONTRIBUTORS BE LIABLE FOR ANY DIRECT, INDIRECT, INCIDENTAL, SPECIAL, EXEMPLARY, OR CONSEQUENTIAL DAMAGES (INCLUDING, BUT NOT LIMITED TO, PROCUREMENT OF SUBSTITUTE GOODS OR SERVICES; LOSS OF USE, DATA, OR PROFITS; OR BUSINESS INTERRUPTION) HOWEVER CAUSED AND ON ANY THEORY OF LIABILITY, WHETHER IN CONTRACT, STRICT LIABILITY, OR TORT (INCLUDING NEGLIGENCE OR OTHERWISE) ARISING IN ANY WAY OUT OF THE USE OF THIS SOFTWARE, EVEN IF ADVISED OF THE POSSIBILITY OF SUCH DAMAGE.

- Microsoft and Windows Media are either registered trademarks or trademarks of Microsoft Corporation in the United States and/or other countries.
- "Made for iPod," and "Made for iPhone" mean that an electronic accessory has been designed to connect specifically to iPod, or iPhone, respectively, and has been certified by the developer to meet Apple performance standards. Apple is not responsible for the operation of this device or its compliance with safety and regulatory standards. Please note that the use of this accessory with iPod or iPhone may affect wireless performance.
- iPhone, iPod, iPod classic, iPod nano, and iPod touch are trademarks of Apple Inc., registered in the U.S. and other countries.
- Lightning is a trademark of Apple Inc.
- Pandora, the Pandora logo, and the Pandora trade dress are trademarks or registered trademarks of Pandora Media, Inc., used with permission.
- iHeartRadio® and iHeartAuto™ are trademarks owned by iHeartMedia, Inc. All uses are authorized under license.
- SPOTIFY and the Spotify logo are among the registered trademarks of Spotify AB.
- Sirius, XM and all related marks and logos are trademarks of Sirius XM Radio Inc. All rights reserved.
- Android is trademark of Google Inc.
- The Bluetooth® word mark and logos are registered trademarks owned by Bluetooth SIG, Inc. and any use of such marks by JVC KENWOOD Corporation is under license. Other trademarks and trade names are those of their respective owners.



WHEN IT IS NOT REQUIRED  
TO DETACH THE FRONT CONTROL  
PANEL FROM THE MAIN UNIT,  
USE THE PROVIDED SCREW TO  
ATTACH THE CONTROL PANEL TO  
THE MAIN UNIT.

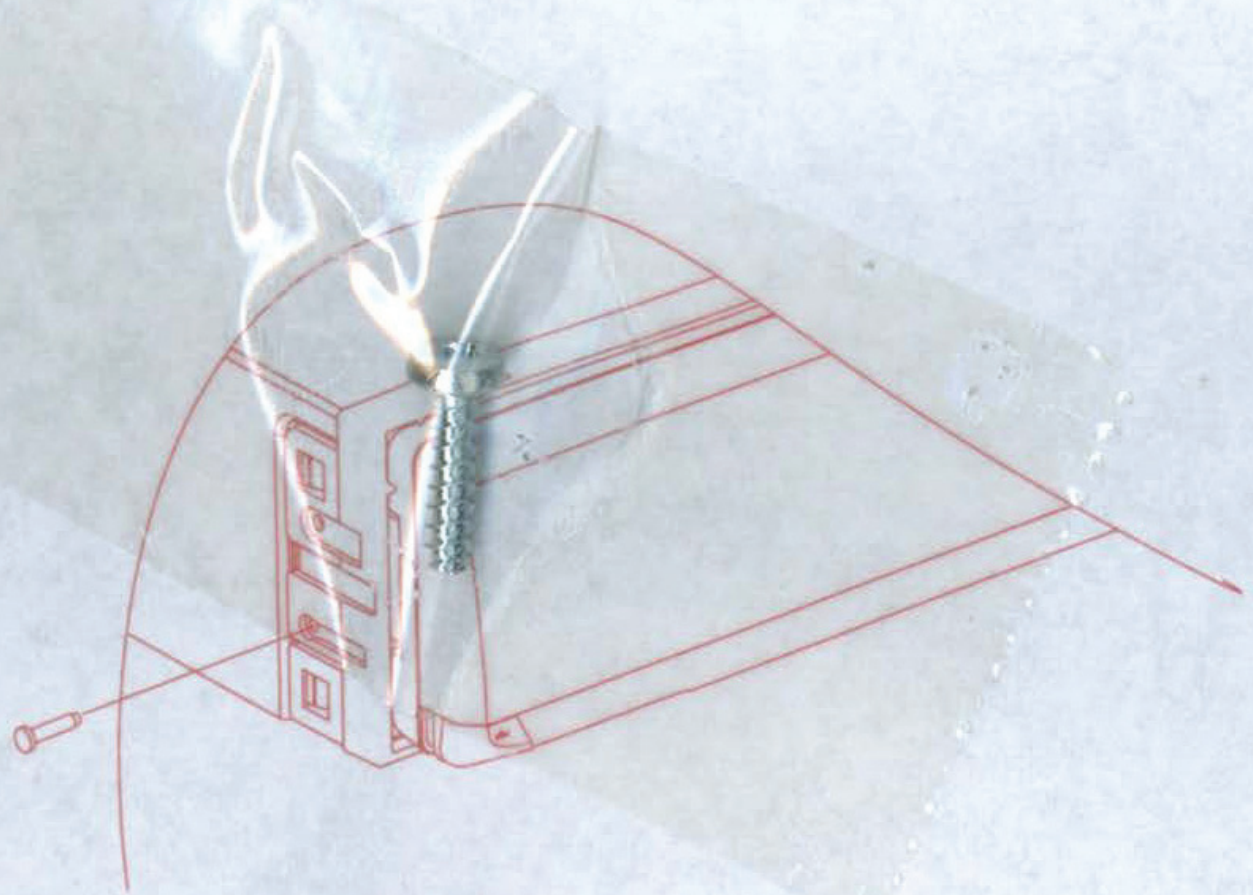

GE40401-001A

## TO OUR VALUED CUSTOMER

THANK YOU FOR PURCHASING THIS JVC PRODUCT.  
WE WANT TO HELP YOU ACHIEVE A PERFECT EXPERIENCE.

**NEED HELP ON HOW TO HOOK UP?  
NEED ASSISTANCE ON HOW TO OPERATE?  
NEED TO LOCATE A JVC SERVICE CENTER?  
LIKE TO PURCHASE ACCESSORIES?**

**JVC IS HERE TO HELP!**  
**TOLL FREE: 1 (800)252-5722**  
**<http://www.us.jvckenwood.com>**

Remember to retain your Bill of Sale for Warranty Service.  
**Do not attempt to service the product yourself**

### Caution

To prevent electrical shock, do not open the cabinet.  
There are no user serviceable parts inside.  
Please refer to qualified service personnel for repairs.

### PRODUCT REGISTRATION

We suggest that you register your product since it will enable us to contact you directly if it is ever necessary to correct a safety related condition in your product. You can register at [www.register.jvc.com](http://www.register.jvc.com)  
Please note that failure to register does not diminish any of your rights during the warranty period.

# JVC

## LIMITED WARRANTY

ONLY FOR PRODUCT PURCHASED IN U.S.A.

JVCKENWOOD USA Corporation warrants this product and all parts thereof, except as set forth below ONLY TO THE ORIGINAL RETAIL PURCHASER to be FREE FROM DEFECTIVE MATERIALS AND WORKMANSHIP from the date of original purchase for the period shown below. ("The Warranty Period")

PARTS 2 YRS / LABOR 2 YRS : Car audio ARSENAL series

PARTS 1 YR / LABOR 1 YR : All other car audio products

**THIS LIMITED WARRANTY IS VALID ONLY IN THE FIFTY (50) UNITED STATES, THE DISTRICT OF COLUMBIA AND IN THE COMMONWEALTH OF PUERTO RICO.**

### WHAT WE WILL DO:

If this product is found to be defective within the warranty period, JVC will repair or replace defective parts with new or rebuilt equivalents at no charge to the original owner. Such repair and replacement services shall be rendered by JVC during normal business hours at JVC authorized service centers. Parts used for replacement are warranted only for the remainder of the Warranty Period. All products may be brought to a JVC authorized service center on a carry-in basis. Color televisions with a screen size of 37" class or greater qualify for in-home service. In such cases, a technician will come to your home and either repair the TV there or remove and return it if it cannot be repaired in your home.

### WHAT YOU MUST DO FOR WARRANTY SERVICE:

Please do not return your product to the retailer. Instead, return your product to the JVC authorized service center nearest you. If shipping the product to the service center, please be sure to package it carefully, preferably in the original packaging, and include a brief description of the problem(s) and a copy of the proof of purchase to verify purchase date. Please call 1-800-252-5722 to locate the nearest JVC authorized service center. Service locations can also be obtained from our website <http://www.us.jvckenwood.com>. If your product qualifies for in-home service, the service representative will require clear access to the product.

If you have any questions concerning your JVC Product, please contact our Customer Care Center at 800-252-5722

### WHAT IS NOT COVERED:

This limited warranty provided by JVC does not cover:

1. Products which have been subject to abuse, accident, alteration, modification, tampering, negligence, misuse, faulty installation, lack of reasonable care, or if repaired or serviced by anyone other than a service facility authorized by JVC to render such service, or if affixed to any attachment not provided with the products, or if the model or serial number has been altered, tampered with, defaced or removed;
2. Initial installation, installation and removal from cabinets or mounting systems.
3. Operational adjustments covered in the Owner's Manual, normal maintenance, video and audio head cleaning;
4. Damage that occurs in shipment, due to act of God, and cosmetic damage;
5. Signal reception problems and failures due to line power surge;
6. User Removal Memory Devices/Video Pick-up Tubes/CCD Image Sensors are covered for 90 days from the date of purchase;
7. Accessories;
8. Batteries (except that Rechargeable Batteries are covered for 90 days from the date of purchase);
9. Products used for commercial purposes, including, but not limited to rental.
10. Loss of data resultant from malfunction of hard drive or other data storage device;

There are no express warranties except as listed above.

THE DURATION OF ANY IMPLIED WARRANTIES, INCLUDING THE IMPLIED WARRANTY OF MERCHANTABILITY, IS LIMITED TO THE DURATION OF THE EXPRESS WARRANTY HEREIN. JVC SHALL NOT BE LIABLE FOR ANY LOSS OF USE OF THE PRODUCT, INCONVENIENCE, OR ANY OTHER DAMAGES, WHETHER DIRECT, INCIDENTAL OR CONSEQUENTIAL (INCLUDING, WITHOUT LIMITATION, DAMAGE TO TAPES, RECORDS OR DISCS) RESULTING FROM THE USE OF THIS PRODUCT, OR ARISING OUT OF ANY BREACH OF THIS WARRANTY. ALL EXPRESS AND IMPLIED WARRANTIES, INCLUDING THE WARRANTIES OF MERCHANTABILITY AND FITNESS FOR PARTICULAR PURPOSE, ARE LIMITED TO THE WARRANTY PERIOD SET FORTH ABOVE.

Some states do not allow the exclusion of incidental or consequential damages or limitations on how long an implied warranty lasts, so these limitations or exclusions may not apply to you. This warranty gives you specific legal rights and you may also have other rights which vary from state to state.

### JVCKENWOOD USA Corporation

PO Box 22745, 2201 East Dominguez Street, Long Beach, CA90801-5745  
<http://www.us.jvckenwood.com>

REFURBISHED PRODUCTS CARRY A SEPARATE WARRANTY, THIS WARRANTY DOES NOT APPLY. FOR DETAIL OF REFURBISHED PRODUCT WARRANTY, PLEASE REFER TO THE REFURBISHED PRODUCT WARRANTY INFORMATION PACKAGED WITH EACH REFURBISHED PRODUCT.

### For customer use:

Enter below the Model No. and Serial No. which is located either on the rear, bottom or side of the cabinet. Retain this information for future reference.

Model No.:

Serial No.:

Purchase date:

Name of dealer:



**JVC****WARRANTY**

Warranty applies only to PRODUCT distributed in Canada by JVCKENWOOD CANADA INC.

JVCKENWOOD CANADA INC. (hereafter called "JVC") gives the following express warranty for each new JVC product distributed in Canada by JVC and sold by an authorized JVC dealer. JVC warrants that this JVC product is free, under normal use and maintenance, from any defects in material and workmanship subject to the following terms and conditions:

- To Obtain Warranty Service:**
  - JVC product requiring service must be presented together with proof of purchase.
  - The JVC product must be brought in for service to an authorized JVC Service Centre.
- Limitation:**  
This Warranty shall not apply to:
  - Repair or replacement of any cabinets, batteries, plates, connection cords, antennas, dust covers, knobs, speaker grills, speaker cones, projection screens, projection screen savers, and all accessories.
  - Any defects caused or repairs required as a result of misuse, abusive operation, negligence, improper use and/or insufficient care.
  - Any defect caused or repairs required as a result of not following the instructions in the operation manual.
  - Any JVC product tampered with, adjusted or repaired by any party other than JVC or authorized JVC Service Centre personnel.
  - Any JVC products on which the serial number has been defaced, modified or removed.
  - Maintenance, cleaning or periodic check-up
  - Conversion to foreign or domestic voltage or frequency.
  - Any JVC product without the Canadian Electrical Safety Regulations ID.
  - Any JVC products used for commercial or institutional, rental, or display purposes.  
Parts ..... 1 year (except video head - 90 days)  
Labour ... 90 days
  - Any JVC product which has been resold and no longer owned by the original purchaser.
  - Product purchased from "outside Canada", "bankruptcy" or "liquidator".
  - Any defects caused by fire, flood, lightning, power surge, or other events beyond the control of JVC.
- FOR AUTO PRODUCTS**  
Warranty does not cover elimination of car static or electrical interferences, cleaning of head, adjustments, or labour cost for the removal or reinstallation of the unit for repair.

- Standards:**  
If any defects should be found in a JVC product within the applicable terms, necessary repairs shall be made at no cost to the purchaser for parts or labour when JVC acknowledges that such defects are due to faulty material or workmanship.
- Exclusion of All Other Express Warranties:**  
This warranty constitutes the entire express warranty given by JVC for JVC products and no dealer or service centre personnel or his, its or their agent or employee is, or are authorized to extend or enlarge this warranty on behalf of JVC.
- Disclaimer of Consequential Damage:**  
To the extent the law permits JVC disclaims any responsibility for loss of time or use of its product, transportation costs, or any other indirect, incidental or consequential damage or inconvenience.

**WARRANTY TERM (VALID FROM THE DATE OF PURCHASE)**

| Product   | Parts (Years) | Labour (Years) |
|---|---------------|----------------|
| Projection TV In-Home Service<br>Colour TV In-Home (25" and above)<br>D-ILA Rear Projection In-Home Service<br>LCD TV In-Home Service (25" and above)   | 1             | 1              |
| * In-Home service to be provided where available. Where it is not available, the purchaser must assume the responsibility and expense for the proper packing, shipment and all costs associated with the delivery of the equipment to and from the closest JVC Authorized Service Centre. |               |                |
| Receivers and Home Speakers purchased separately. Front Projection and Car Audio "ARSENAL" Series   | 2             | 2              |
| AC Adapters, Remote controls, Headphones, Microphones and Projector lamps   | 90 days       | 90 days        |
| Wood Cone Speakers  | 5             | 5              |
| All Other Categories  | 1             | 1              |

**JVCKENWOOD CANADA INC.**

6070 Kestrel Road, Mississauga, Ontario, L5T 1S8 Canada  
 TEL: (905) 670-3381 FAX: (905)670-7244 Service toll free #: 1-800-964-2650  
<http://www.jvc.ca> E-mail: [service@jvc.ca](mailto:service@jvc.ca)

**Product Registration**

We suggest that you register your product since it will enable us to contact you directly if it is ever necessary to correct a safety related condition in your product. You can register at <http://www.jvc.ca/www/Support/Warranty.aspx>

**For customer use:**

Enter below the Model No. and Serial No. which is located either on the rear, bottom or side of the cabinet. Retain this information for future reference.

Model No.: \_\_\_\_\_ Serial No.: \_\_\_\_\_  
 Purchase date: \_\_\_\_\_ Name of dealer: \_\_\_\_\_

**GARANTIE**

La garantis' applique seulement aux PRODUITS distribués au Canada par JVCKENWOOD CANADA INC.

JVCKENWOOD CANADA INC. ( ci-après appelé "JVC") énonce la garantie expresse suivante pour tout nouveau produit JVC distribué au Canada par JVC et vendu par un détaillant JVC autorisé. JVC vous garantit que ce produit est dégage, sous utilisation et entretien normal, de tout défaut matériel et de fabrication sous réserve des modalités et conditions suivantes:

- Pour obtenir un service de garantie:**
  - Les produits JVC nécessitant un service doit être présentée avec la preuve d'achat.
  - Le produit JVC doit être apporté pour service chez un centre de service JVC autorisé.
- Restrictions:**  
Cette garantie ne s'applique pas aux:
  - Réparation ou remplacement de tout cabinet, batteries, panneau avant, cordons de raccord, antennes, housses de protection, boutons, couverts de hautparleur, cônes de hautparleur, écrans de projection, protecteurs d'écran de projection et tous les accessoires.
  - Tous défauts occasionnés ou réparations requises suite à une utilisation abusive, mauvaise, négligente et/ou une utilisation incorrecte.
  - Tous défauts occasionnés ou réparations requises suite à l'omission de suivre les recommandations du manuel d'instruction.
  - Tout produit JVC altéré, ajusté ou réparé par tout autre entreprise que JVC ou un centre de service d'entretien ou de service autorisé JVC.
  - Tout produit JVC dont le numéro de série a été altéré, modifié ou enlevé.
  - L'entretien, les vérifications périodiques et nettoyage.
  - La conversion à une fréquence ou une tension étrangère ou domestique.
  - Tout produit JVC n'ayant pas le signe d'identification qui conforme aux normes électriques Canadiennes (CSA).
  - Pour tout produit utilisé à des fins commerciales, institutionnelles, de location ou utilisé à des fins d'étalage.  
Pièces ..... 1 An (Excepté les têtes vidéo- 90 jours)  
Main d'oeuvre ... 90 Jours
  - Tout produit JVC ayant été revendu et qui n'est plus la propriété de l'acheteur original.
  - Produit acheté à "l'extérieur du Canada", provenant d'une "faillite" ou d'un "liquidateur".
  - Tout dommage causé par le feu, une inondation, un éclair, une surtension ou tout autre évènement hors du contrôle de JVC.

- POUR LES PRODUITS D'AUTOMOBILE**  
La garantie ne couvre pas l'élimination d'interférences statiques ou électriques de la voiture, le nettoyage de tête, les ajustements et les coûts de main d'œuvre associés à l'enlèvement ou à la réinstallation de l'unité pour réparation.
- Critères:**  
Si un produit JVC s'avérait défectueux, selon les conditions applicables, les réparations nécessaires seront effectués sans coûts additionnels à l'acheteur pour les pièces et la main d'œuvre lorsque JVC reconnaît que de tels défauts ont été causés par une défectuosité de matériel ou de fabrication.
- Exclusion de toutes autres garanties expresses :**  
Cette garantie constitue l'entière garantie expresse donnée par JVC pour les produits JVC. Nul représentant ou employé d'un détaillant ou d'un service d'entretien n'est autorisé à prolonger cette garantie au nom de JVC.
- Dénégation des dommages indirects:**  
Dans la mesure permise par la loi, JVC nie toute responsabilité pour perte de temps ou d'usage de ses produits, des coûts de transport ou tout autre dommage ou inconfort indirect, accidentel et consécutif.

**CONDITIONS DE GARANTIE (VALABLE À PARTIR DE LA DATE D'ACHAT)**

| Produit  | Pieces (Années) | Main-D'oeuvre (Années) |
|--|-----------------|------------------------|
| Ecrans de projection Service à Domicile<br>Ecrans de TV Couleur Service à Domicile (25" et plus)<br>TV projection arrière D-ILA Service à Domicile<br>Ecrans de LCD Service à Domicile (25" et plus)   | 1               | 1                      |
| * Service à domicile fourni par un détaillant disponible. S'il n'y a pas de service JVC disponible à proximité, l'acheteur doit assumer la responsabilité et les coûts pour un emballage adéquat, l'expédition, ainsi que tous les coûts associés à la livraison de l'équipement chez et depuis le détaillant JVC autorisé le plus près pour un service d'entretien. |                 |                        |
| Récepteurs et Hauts-Parleurs achetés séparément, Projecteur Avant et Audio d'Auto de Série "ARSENAL"   | 2               | 2                      |
| Adaptateurs AC, Télécommande, Casque D'écoute, Microphones et Lampe de Projecteur  | 90 Jours        | 90 Jours               |
| Enceinte à Cône en Bois  | 5               | 5                      |
| Toutes les autres catégories   | 1               | 1                      |

**JVCKENWOOD CANADA INC.**

6070 Kestrel Road, Mississauga, Ontario, L5T 1S8 Canada  
 TEL: (905) 670-3381 FAX: (905)670-7244 Service toll free #: 1-800-964-2650  
<http://www.jvc.ca> E-mail: [service@jvc.ca](mailto:service@jvc.ca)

**Enregistrement du produit**

Nous vous conseillons d'enregistrer votre produit, car il nous permettra de vous contacter directement si jamais elle est nécessaire pour corriger un problème lié à la sécurité de votre produit. Vous pouvez vous inscrire à <http://www.jvc.ca/www/Support/Warranty.aspx>

**Pour l'utilisation des clients:**

Entrez ci-dessous le numéro de modèle et le numéro de série qui se trouve soit à l'arrière, en bas ou sur le côté de l'armoire. Conservez ces informations pour référence future.

No. de modèle: \_\_\_\_\_ No. de série: \_\_\_\_\_  
 Date d'achat: \_\_\_\_\_ Nom du revendeur: \_\_\_\_\_